

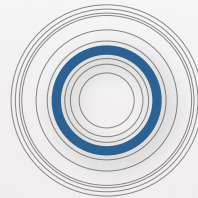

JDENTAL CARE
just smile

JD ICON **PLUS**

Bone tissue implant system



conical connection



Made in Italy

BONE TISSUE IMPLANT SYSTEM

ONE CONNECTION for all sizes of fixtures and a simplified restorative workflow
EXCELLENT PRIMARY STABILITY even in small osteotomies
COMPLETE VARIETY OF PROSTHETIC OPTIONS for best aesthetic results

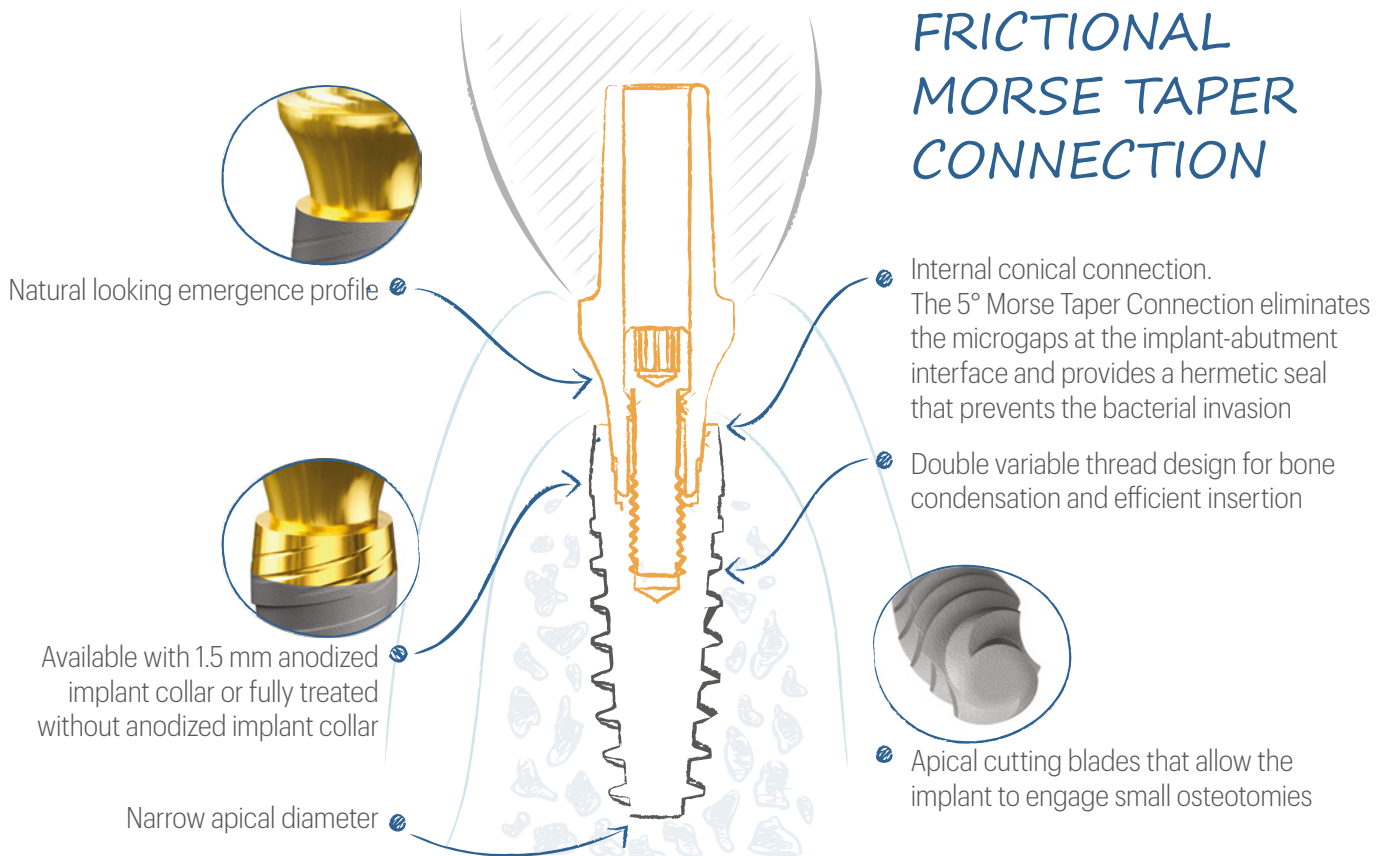

BONE TISSUE SURFACE TREATMENT

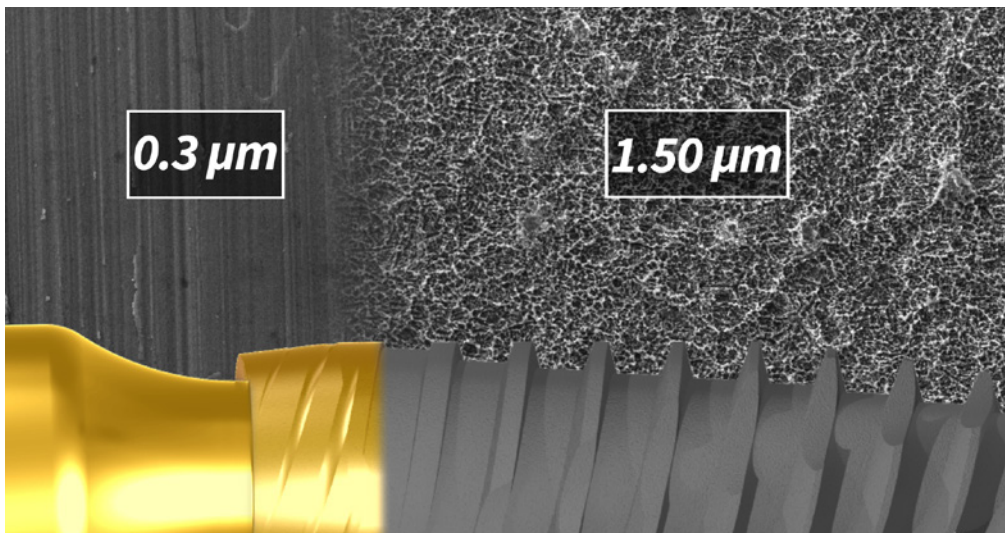

The JDIcon Plus dental implants are available in two versions:

1. Fully treated with SLA surface treatment
2. With 1.5 mm anodized implant collar and the body surface treated with SLA

The S.L.A. surface is obtained through the procedure of sandblasting with large grit and acid-etching (SLA) which guarantees an optimal microtopography of the implant surface that improves the osteointegration.

Note: The picture above is generated by a Scanning electron microscope (SEM) and shows the roughness values, expressed as Ra, of the two surfaces of the implant treated with S.L.A. and Anodization.

PRODUCT SPECIFICATIONS

The JDIcon Plus dental implants are available in the diameters and lengths shown in the following table

IMPLANT DIAMETER	TIP DIAMETER	ABUTMENT INTERFACE	PLATFORM DIAMETER	LENGTH						
				6	8	10	11,5	13	15	18
Ø 3,7	2,4	3,1	3,7		8	10	11,5	13	15	18
Ø 4,3	2,8	3,1	4,0	6	8	10	11,5	13	15	18
Ø 5,0	3,2	3,1	4,8	6	8	10	11,5	13		

Note: all measurements in mm

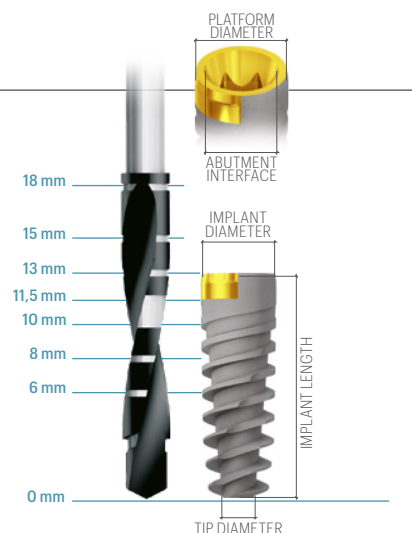

PRODUCT CATALOGUE

Note: all measurements of diameters and lengths are in mm

JDIcon Plus:

Ø 3,7

IC37080.	JDIcon Plus Ø 3,7 L 8
IC37100.	JDIcon Plus Ø 3,7 L 10
IC37115.	JDIcon Plus Ø 3,7 L 11,5
IC37130.	JDIcon Plus Ø 3,7 L 13
IC37150.	JDIcon Plus Ø 3,7 L 15
IC37180.	JDIcon Plus Ø 3,7 L 18

Ø 4,3

IC43060.	JDIcon Plus Ø 4,3 L 6
IC43080.	JDIcon Plus Ø 4,3 L 8
IC43100.	JDIcon Plus Ø 4,3 L 10
IC43115.	JDIcon Plus Ø 4,3 L 11,5
IC43130.	JDIcon Plus Ø 4,3 L 13
IC43150.	JDIcon Plus Ø 4,3 L 15
IC43180.	JDIcon Plus Ø 4,3 L 18

Ø 5,0

IC50060.	JDIcon Plus Ø 5,0 L 6
IC50080.	JDIcon Plus Ø 5,0 L 8
IC50100.	JDIcon Plus Ø 5,0 L 10
IC50115.	JDIcon Plus Ø 5,0 L 11,5
IC50130.	JDIcon Plus Ø 5,0 L 13

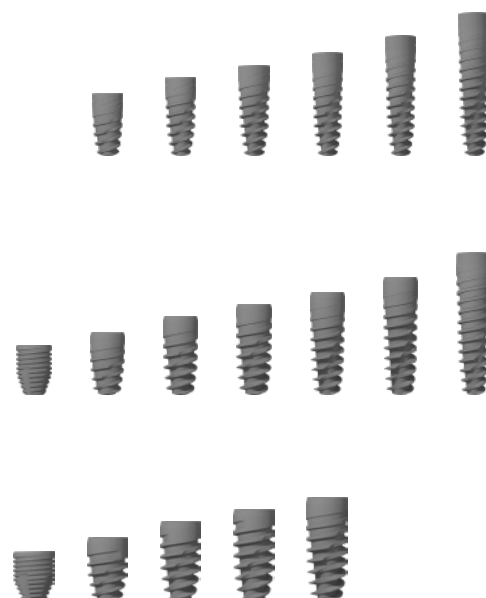

JDIcon Plus (anodised collar):

Ø 3,7

IC37080,	JDIcon Plus Anodized Collar Ø 3,7 L 8
IC37100,	JDIcon Plus Anodized Collar Ø 3,7 L 10
IC37115,	JDIcon Plus Anodized Collar Ø 3,7 L 11,5
IC37130,	JDIcon Plus Anodized Collar Ø 3,7 L 13
IC37150,	JDIcon Plus Anodized Collar Ø 3,7 L 15
IC37180,	JDIcon Plus Anodized Collar Ø 3,7 L 18

Ø 4,3

IC43060,	JDIcon Plus Anodized Collar Ø 4,3 L 6
IC43080,	JDIcon Plus Anodized Collar Ø 4,3 L 8
IC43100,	JDIcon Plus Anodized Collar Ø 4,3 L 10
IC43115,	JDIcon Plus Anodized Collar Ø 4,3 L 11,5
IC43130,	JDIcon Plus Anodized Collar Ø 4,3 L 13
IC43150,	JDIcon Plus Anodized Collar Ø 4,3 L 15
IC43180,	JDIcon Plus Anodized Collar Ø 4,3 L 18

Ø 5,0

IC50060,	JDIcon Plus Anodized Collar Ø 5,0 L 6
IC50080,	JDIcon Plus Anodized Collar Ø 5,0 L 8
IC50100,	JDIcon Plus Anodized Collar Ø 5,0 L 10
IC50115,	JDIcon Plus Anodized Collar Ø 5,0 L 11,5
IC50130,	JDIcon Plus Anodized Collar Ø 5,0 L 13



Cover screw:

ICCS. Cover Screw JDIcon Plus



Healing Abutment:

ICHA43. Healing Abutment Ø 4.0 H 3.0 JDIcon Plus
 ICHA45. Healing Abutment Ø 4.0 H 5.0 JDIcon Plus
 ICHA47. Healing Abutment Ø 4.0 H 7.0 JDIcon Plus
 ICHA53. Healing Abutment Ø 5.0 H 3.0 JDIcon Plus
 ICHA55. Healing Abutment Ø 5.0 H 5.0 JDIcon Plus
 ICHA57. Healing Abutment Ø 5.0 H 7.0 JDIcon Plus
 ICHA63. Healing Abutment Ø 6.0 H 3.0 JDIcon Plus
 ICHA65. Healing Abutment Ø 6.0 H 5.0 JDIcon Plus
 ICHA67. Healing Abutment Ø 6.0 H 7.0 JDIcon Plus
 ICHA753. Healing Abutment Ø 7.5 H 3.0 JDIcon Plus
 ICHA755. Healing Abutment Ø 7.5 H 5.0 JDIcon Plus



Impression Coping:

OPEN TRAY

ICICOT4C. Impression Coping Open Tray Ø 4.0 JDIcon Plus
 ICICOT5C. Impression Coping Open Tray Ø 5.0 JDIcon Plus
 ICICOT6C. Impression Coping Open Tray Ø 6.0 JDIcon Plus

CLOSED TRAY

ICICCT4C. Impression Coping Closed Tray Ø 4.0 JDIcon Plus
 ICICCT5C. Impression Coping Closed Tray Ø 5.0 JDIcon Plus
 ICICCT6C. Impression Coping Closed Tray Ø 6.0 JDIcon Plus
 ICICCT1C. Impression Coping Closed Tray Direct Press Fit JDIcon Plus

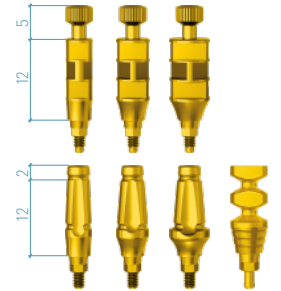

Temporary Abutment:

ICTAEC. Temporary Abutment Engaging JDIcon Plus
 ICTANEC. Temporary Abutment Non Engaging JDIcon Plus

Torque recommended 30 Ncm



Straight Abutment:

ICA130C. Straight Abutment Ø 4.5 H 1.5 JDIcon Plus
 ICSA4520C. Straight Abutment Ø 4.5 H 2.0 JDIcon Plus
 ICSA4520NEC. Straight Abutment Non Engaging Ø 4.5 H 2.0 JDIcon Plus
 ICSA4540C. Straight Abutment Ø 4.5 H 4.0 JDIcon Plus
 ICSA4540NEC. Straight Abutment Non Engaging Ø 4.5 H 4.0 JDIcon Plus
 ICSA5020C. Straight Abutment Ø 5.0 H 2.0 JDIcon Plus
 ICSA5020NEC. Straight Abutment Non Engaging Ø 5.0 H 2.0 JDIcon Plus
 ICSA5040C. Straight Abutment Ø 5.0 H 4.0 JDIcon Plus
 ICSA5040NEC. Straight Abutment Non Engaging Ø 5.0 H 4.0 JDIcon Plus
 ICSA6020C. Straight Abutment Ø 6.0 H 2.0 JDIcon Plus
 ICSA6040C. Straight Abutment Ø 6.0 H 4.0 JDIcon Plus

Torque recommended 30 Ncm



Torque recommended 30 Ncm



GP Abutment:

ICGP40C. GP Abutment Ø 4.0 JDIcon Plus
 ICGP50C. GP Abutment Ø 5.0 JDIcon Plus
 ICGP60C. GP Abutment Ø 6.0 JDIcon Plus
 IC15GPAEC. GP Abutment 15° JDIcon Plus
 IC25GPAEC. GP Abutment 25° JDIcon Plus

Torque recommended 30 Ncm



Anatomic Abutment:

IC15A15C. Anatomic Abutment Angulated 15° H 1.5 JDIcon Plus
 IC15A30C. Anatomic Abutment Angulated 15° H 3.0 JDIcon Plus
 IC25A15C. Anatomic Abutment Angulated 25° H 1.5 JDIcon Plus
 IC25A30C. Anatomic Abutment Angulated 25° H 3.0 JDIcon Plus

Torque recommended 30 Ncm



Cobalt-Chrome Abutment:

ICCCEC. Cobalt-Chrome Abutment Engaging JDIcon Plus
 ICCNEC. Cobalt-Chrome Abutment Non Engaging JDIcon Plus
 EVCACCNEC. Cobalt-Chrome Conical Abutment Non Engaging JDEvolution

Torque recommended 30 Ncm

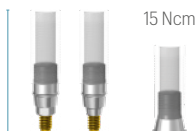

15 Ncm

Prosthetic screw:

ICS.	Prosthetic Screw JDIcon Plus
ICSA.	Prosthetic Screw Angulated JDIcon Plus

Torque recommended 30 Ncm



Extra Abutment:

ICEXA5520C.	Straight Abutment Extra Ø 5.5 H 2.0 JDIcon Plus
ICEXA5540C.	Straight Abutment Extra Ø 5.5 H 4.0 JDIcon Plus
ICEXTIBC.	TiBase Extra Engaging Ø4.25 H 0.5 C 4.7 JDIcon Plus
ICEXTIBNEC.	TiBase TiBase Extra Non Engaging Ø4.25 H 0.5 C 4.7 JDIcon Plus
ICEXTIB15C.	TiBase Extra Engaging Ø4.25 H 1.5 C 4.7 JDIcon Plus
ICEXTIB15NEC.	TiBase Extra Non Engaging Ø4.25 H 1.5 C 4.7 JDIcon Plus
ICEXTIB30C.	TiBase Extra Engaging Ø4.25 H 3.0 C 4.7 JDIcon Plus
ICEXTIB30NEC.	TiBase Extra Non Engaging Ø4.25 H 3.0 C 4.7 JDIcon Plus



Torque recommended 30 Ncm

Octa Abutment:

ICOA15.	Octa Abutment H 1.5 JDIcon Plus
ICOA30.	Octa Abutment H 3.0 JDIcon Plus
ICOA40.	Octa Abutment H 4.0 JDIcon Plus
ICOA50.	Octa Abutment H 5.0 JDIcon Plus
ICOA60.	Octa Abutment H 6.0 JDIcon Plus
ICOAHC.	Healing Cap Octa Abutment JDIcon Plus
ICOAHC54.	Healing Cap Octa Abutment D 5.0 H 4.0 JDIcon Plus
ICOAICOTC.	Impression Coping Open Tray for Octa Abutment JDIcon Plus
ICOAICOTEC.	Impression Coping Open Tray Engaging for Octa Abutment JDIcon Plus
ICOAR.	Octa Abutment Replica JDIcon Plus
ICOAPS.	Prosthetic Screw Octa Abutment JDIcon Plus
ICOAPSA.	Prosthetic Screw Angulated Octa Abutment JDIcon Plus
ICOAWANEC.	Wax-Up Abutment Non Engaging Octa Abutment JDIcon Plus
ICOATANEC.	Temporary Abutment Non Engaging Octa Abutment JDIcon Plus
ICOATAEC.	Temporary Abutment Engaging Octa Abutment JDIcon Plus
ICOAITC.	Interface CAD CAM Octa Abutment JDIcon Plus (Ø4.45 C7.3)
ICOAITEC.	Interface CAD CAM Engaging Octa Abutment JDIcon Plus (Ø4.45 C7.3)
ICOATIBC.	TiBase Octa Abutment JDIcon Plus (Ø4.45 C5.0)
ICOATIBEC.	TiBase Octa Abutment Engaging JDIcon Plus (Ø4.45 C5.0)
ICOASBCEC.	ScanBody Octa Abutment JDIcon Plus
ICOASBCEEC.	ScanBody Engaging Octa Abutment JDIcon Plus
ICOARC.	Octa Abutment Replica CAD CAM JDIcon Plus

Torque recommended 30 Ncm



Torque recommended 30 Ncm

Torque recommended 30 Ncm

Torque recommended 30Ncm

Conical Abutment:

ICCA15C.	Conical Abutment H 1.5 JDIcon Plus
ICCA30C.	Conical Abutment H 3.0 JDIcon Plus
ICCA40C.	Conical Abutment H 4.0 JDIcon Plus
ICCA1725C.	Conical Abutment Angulated 17° H 2.5 JDIcon Plus
ICCA1735C.	Conical Abutment Angulated 17° H 3.5 JDIcon Plus
ICCA3025C.	Conical Abutment Angulated 30° H 2.5 JDIcon Plus
ICCA3035C.	Conical Abutment Angulated 30° H 3.5 JDIcon Plus
ICCASA.	Conical Abutment Angulated Screw JDIcon Plus
EVCAPS	Prosthetic Screw Conical Abutment JDEvolution
EVCAPSA	Prosthetic Screw Angulated for Conical Abutment JDEvolution
EVCAICOTEC	Conical Abutment Impression Coping Open Tray Engaging JDEvolution
EVCAICOTC	Conical Abutment Impression Coping Open Tray JDEvolution
EVCAICOTLC	Conical Abutment Impression Coping Open Tray Long JDEvolution
EVCAICOT02	Screw for Conical Abutment Impression Coping Open Tray JDEvolution
EVCAICOT04	Screw for Conical Abutment Impression Coping Open Tray Long JDEvolution
EVCAICCTC	Conical Abutment Impression Coping Closed Tray
EVCAHC	Conical Abutment Healing Cap JDEvolution
EVCAHCL	Conical Abutment Healing Cap H 6.0 JDEvolution
EVCAHC9	Conical Abutment Healing Cap H 9.0 JDEvolution
EVCAHCB	Conical Abutment Healing Cap Peek JDEvolution
EVCAGPAEC	GP Abutment Engaging for Conical Abutment JDEvolution
EVCAGPANEC	GP Abutment Non Engaging for Conical Abutment JDEvolution
EVCATANWSC	Temporary Abutment Non Engaging Conical Abutment Smooth for Welding JDEvolution
EVCATANEC	Temporary Abutment Non Engaging Conical Abutment JDEvolution
EVCATANESC	Temporary Abutment Non Engaging Conical Abutment for Welding JDEvolution
EVCWANEC	Wax-Up Abutment Non Engaging for Conical Abutment
EVCAAR	Conical Abutment Replica

Torque recommended 30 Ncm

Torque recommended 30 Ncm

Torque recommended 30 Ncm

Torque recommended 15 Ncm

Torque recommended 15 Ncm

Torque recommended 15 Ncm

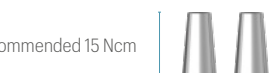
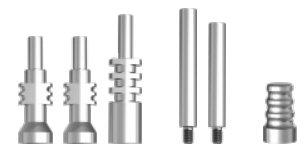
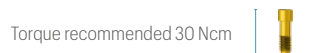

TiBase, JDSanBody and Implant Replica CAD CAM:

ICSBCEC.	ScanBody Engaging JDIcon Plus
EVCASBCEC	ScanBody Conical Abutment JDEvolution
EVCASBCEEC	ScanBody Engaging Conical Abutment
EVCASBCECSC:	On Top ScanBody Conical Abutment JDEvolution Plus*
JDSGCIOS	ScanBody Full Arch Tracer
ICHSB53.	On Top ScanBody Engaging Ø 5.0 H 3.0 JDIcon Plus
ICHSB55.	On Top ScanBody Engaging Ø 5.0 H 5.0 JDIcon Plus
ICHSB57.	On Top ScanBody Engaging Ø 5.0 H 7.0 JDIcon Plus
ICTIBC.	TiBase Engaging Ø4.25 H 0.5 C 4.7 JDIcon Plus
ICTIBNEC.	TiBase Non Engaging Ø4.25 H 0.5 C 4.7 JDIcon Plus
ICTIB15C.	TiBase Engaging Ø4.25 H 1.5 C 4.7 JDIcon Plus
ICTIB15NEC.	TiBase Non Engaging Ø4.25 H 1.5 C 4.7 JDIcon Plus
ICTIB30C.	TiBase Engaging Ø4.25 H 3.0 C 4.7 JDIcon Plus
ICTIB30NEC.	TiBase Non Engaging Ø4.25 H 3.0 C 4.7 JDIcon Plus
ICTIBNC.	TiBase Long engaging Ø4.4 H 0.5 C 7.7 JDIcon Plus
ICTIBNENC.	TiBase Long Non Engaging Ø4.4 H 0.5 C 7.7 JDIcon Plus
ICTIB15NC.	TiBase Long Engaging Ø4.4 H 1.5 C 7.7 JDIcon Plus
ICTIB15NEC.	TiBase Long Non Engaging Ø4.4 H 1.5 C 7.7 JDIcon Plus
ICTIB30NC.	TiBase Long Engaging Ø4.4 H 3.0 C 7.7 JDIcon Plus
ICTIB30NEC.	TiBase Long Non Engaging Ø4.4 H 3.0 C 7.7 JDIcon Plus
ICTIB40NC.	TiBase Long Engaging Ø4.4 H 4.0 C 7.7 JDIcon Plus
ICTIB40NEC.	TiBase Long Non Engaging Ø4.4 H 4.0 C 7.7 JDIcon Plus
EVAITEC	Interface CAD CAM for Conical Abutment Engaging JDEvolution (H 7.5)
EVAI39C	TiBase Engaging for Conical Abutment (H 5.0)
EVAITC	Interface CAD CAM for Conical Abutment Non Engaging JDEvolution (H 7.3)
EVCATIBC	TiBase for Conical Abutment JDEvolution (H 5.0)
EVS110	Prosthetic Screw Conical Abutment Direct
EVS111	Prosthetic Screw Conical Abutment Direct Long
EVS112	Prosthetic Screw for Angulated Channel Conical Abutment Direct
ICANC.	Implant Replica CAD CAM JDIcon Plus
EVCAARCN	Conical Abutment Replica CAD CAM New
ICPMNC.	Pre-milled Abutment Blank JDIcon Plus

*Use JDEvolution Plus screwdriver for screwing

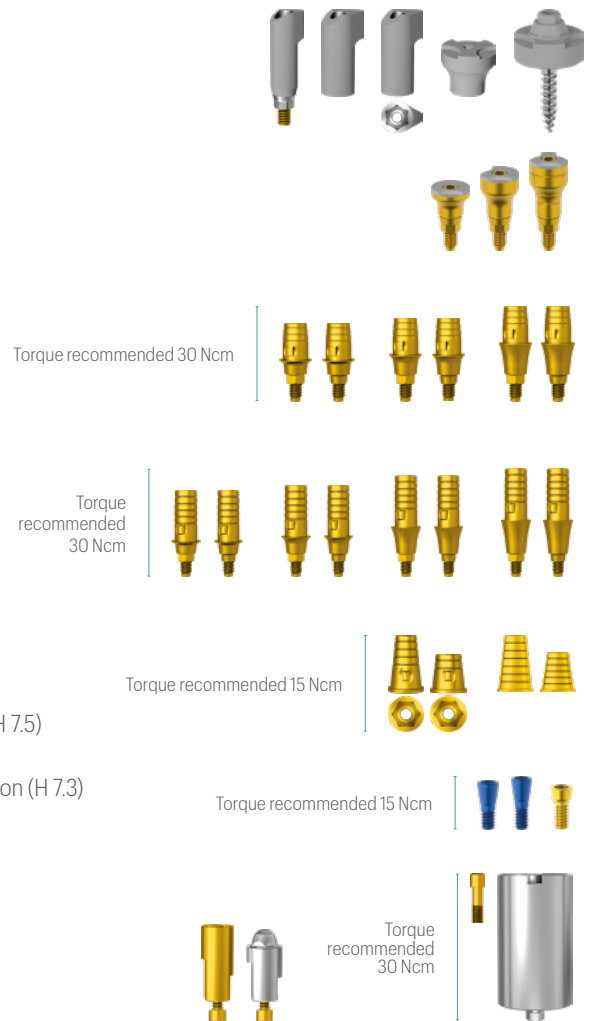

Conometric Abutment:

ICCP05C.	Conometric Abutment Straight H 0.5 JDIcon Plus
ICCP10C.	Conometric Abutment Straight H 1.0 JDIcon Plus
ICCP20C.	Conometric Abutment Straight H 2.0 JDIcon Plus
ICCP30C.	Conometric Abutment Straight H 3.0 JDIcon Plus
ICCP40C.	Conometric Abutment Straight H 4.0 JDIcon Plus
IC7CP20C.	7.5° Angulated Conometric Abutment H 2.0 JDIcon Plus
IC15CP20C.	15° Angulated Conometric Abutment H 2.0 JDIcon Plus
IC22CP20C.	22.5° Angulated Conometric Abutment H 2.0 JDIcon Plus
ICA300C.	30° Angulated Conometric Abutment H 2.0 JDIcon Plus
EVA130C:	Cap With Pin for Intraoral Welding
EVA131C:	Cap for Partial or Full-Arch Fixed Prosthesis
EVA132C:	Anti-Rotation Cap for Single Element
EVCPIC	Conometric Abutment Impression Coping PEEK
EVCPAN	Conometric Abutment Replica

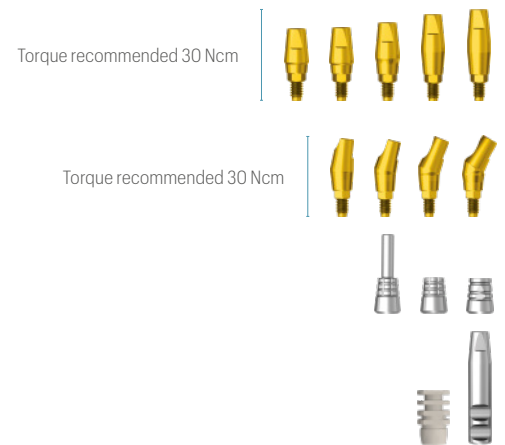

Ball Abutment:

ICBA15.	Ball Abutment H 1.5 JDIcon Plus
ICBA30.	Ball Abutment H 3.0 JDIcon Plus
ICBA50.	Ball Abutment H 5.0 JDIcon Plus
EVBAA	Ball Abutment Replica
EVBAHC	Ball Abutment Elastic Retention Cap w/ Container
EVBAN	Ball Abutment Retention Cap



Emi Abutment:

ICEMI15.	Emi Abutment H 1.5 JDIcon Plus
ICEMI30.	Emi Abutment H 3.0 JDIcon Plus
ICEMI50.	Emi Abutment H 5.0 JDIcon Plus
EVEMISCK	Smart cap attachment Emi Abutment
EVEMIHC	Emi Abutment Elastic Retention Cap w/ Container
EVEMIN	Emi Abutment Elastic Retention Cap (1.2 kg)
EVEMIH	Emi Abutment Container



EVEMIIC	Emi Abutment Plastic Impression Coping
EVEMIICS	Emi Abutment Steel Impression Coping
EVEMINT	Emi Abutment White Retention Cap (1.8 kg)
EVEMINY	Emi Abutment Yellow Retention Cap (0.6 kg)
EVEMINP	Emi Abutment Purple Retention Cap (2.5 kg)
EVEMINB	Emi Abutment Retention Cap for Laboratory
EVEMIA	Emi Abutment Replica
EVEMIEIT	Extractor-insertion Tool For Caps



Implant replica:

ICAN.	Implant Replica JDIcon Plus
-------	-----------------------------



Bone Mill:

ICBM5C.	Bone Mill Ø 5.0 and Guide JDIcon Plus
ICBM6C.	Bone Mill Ø 6.0 and Guide JDIcon Plus
ICBMG.	Bone Mill Guide JDIcon Plus



Short Drills:

JDDICS4	Short Drill Ø 4mm L 6 JDIcon Plus
JDDICS4D	Short Drill Ø 4mm L 6 Dense Bone JDIcon Plus
JDDICS5	Short Drill Ø 5mm L 6 JDIcon Plus



Implant and Prosthetic Drivers:

ICID.	Implant Driver JDIcon Plus
ICIDL.	Implant Driver Long JDIcon Plus
EVSDPF15	Prosthetic Driver for JDTorque L 15
EVSDPF20	Prosthetic Driver for JDTorque L 20
EVSDPF25	Prosthetic Driver for JDTorque L 25
EVSDPF35	Prosthetic Driver for JDTorque L 35
EVSDPF60	Prosthetic Driver for JDTorque L 60
ICOASDF.	Octa Abutment Driver for JDTorque
ICOASDFL.	Octa Abutment Driver Long for JDTorque
EVSDCAF	Conical Abutment Driver for JDTorque
EVSDP20	Prosthetic Driver L 20
EVSDP25	Prosthetic Driver L 25
EVSDP30	Prosthetic Driver L 30
JDPD103	Prosthetic Driver for Surgical Driver
EVSDCA	Conical Abutment Driver
JDPD108	Octa Abutment Driver
EVSDPF25A	Angulated Screw Driver for JDTorque L 25
EVSDPF30A	Angulated Screw Driver for JDTorque L 30
EVSDPF25AV	Angulated Screw Driver for Conical Abutment Direct JDTorque L 25
EVSDPF30AV	Angulated Screw Driver for Conical Abutment Direct JDTorque L 30
ICATR27.	Abutment Removal Driver L 27 JDIcon Plus
ICATR34.	Abutment Removal Driver L 34 JDIcon Plus
EVSUD	Surgical Driver JDEvolution
JDG	JDGuide
ICGMC.	Implant Mounter for JDIcon Plus
ICGMLC.	Implant Mounter Long for JDIcon Plus
JDID105	Conical Abutment Aligning Instrument JDIcon Plus

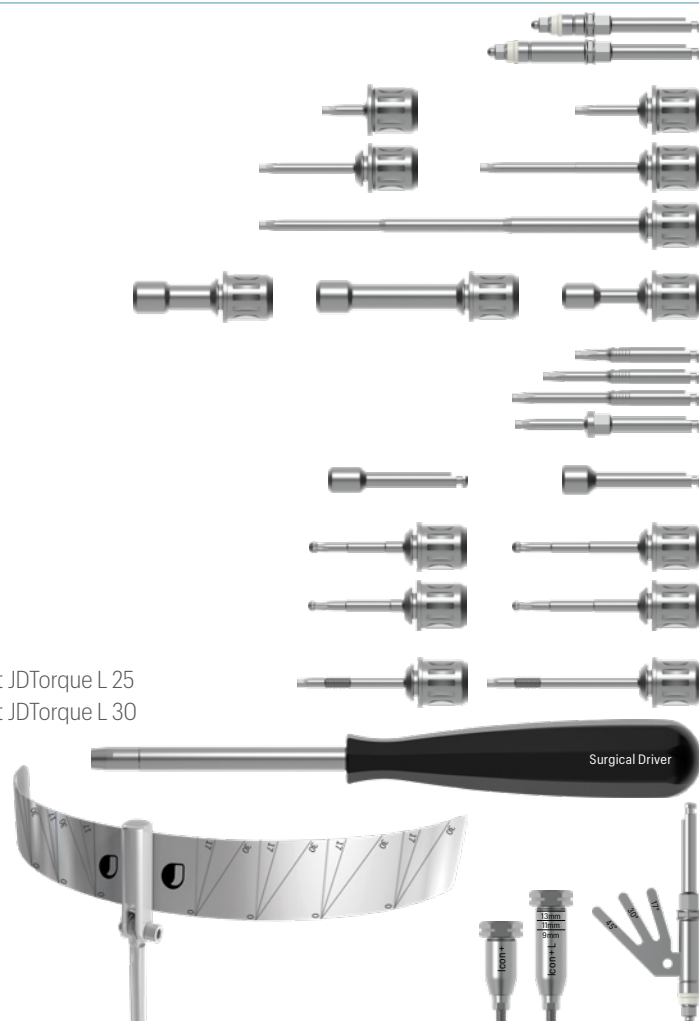



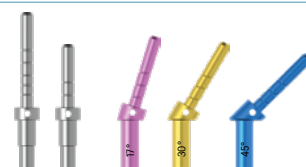

Direction indicators:

JDDI	Direction Indicator
JDDIS	Direction Indicator Short
JDDI17	Direction Indicator 17°
JDDI30	Direction Indicator 30°
JDDI45	Direction Indicator 45°



DRILLING PROTOCOLS

It is recommended to adhere to the indications of the following drilling sequence to ensure optimal primary stability of the implant

IMPLANT DIAMETER	HEALED BONE		POST EXTRACTIVE BONE		
	SOFT BONE	MEDIUM-DENSE BONE	SOFT BONE	MEDIUM-DENSE BONE	
site preparation in maxilla					
Ø 3,7	2,0 2,4 2,8 up to the 1 st laser mark L 6mm	2,0 2,4 2,8 3,2 up to the 1 st laser mark L 6mm	2,0 2,4 2,8 at the entrance	2,0 2,4 2,8 at the entrance	  <p>Short Implant L 6mm JDIcon Plus insertion in maxilla</p>
	Ø 4,3	2,0 2,4 2,8 3,2 at the entrance	2,0 2,4 2,8 3,2 up to the 1 st laser mark L 6-8mm 3,6 at the entrance	2,0 2,4 2,8 3,2 at the entrance	
Ø 5,0	2,0 2,4 2,8 3,2 3,6 up to the 1 st laser mark L 6mm	2,0 2,4 2,8 3,2 3,6 up to the 1 st laser mark L 6mm 4,0 at the entrance	2,0 2,4 2,8 3,2 3,6 at the entrance up to the 1 st laser mark L 6mm	2,0 2,4 2,8 3,2 3,6 at the entrance up to the 1 st laser mark L 6mm	<p>short Ø 5,0 L 6</p> <p>Use the Ø 4mm L6 JDIcon Plus+ drill JDDICS4D</p>
site preparation in mandible					
Ø 3,7	2,0 2,4 2,8 3,2 at the entrance 3,6 at the entrance up to the 1 st laser mark L6mm	2,0 2,4 2,8 3,2 3,6 up to the 1 st laser mark L 6mm	2,0 2,4 2,8 3,2 at the entrance	2,0 2,4 2,8 3,2 at the entrance	  <p>Short Implant L 6mm JDIcon Plus insertion in mandible</p>
	Ø 4,3	2,0 2,4 2,8 3,2 3,6 at the entrance 4,0 at the entrance up to the 2 nd laser mark L8mm	2,0 2,4 2,8 3,2 3,6 4,0 up to the 2 nd laser mark L8mm 4,4 up to the 1 st laser mark L 6mm	2,0 2,4 2,8 3,2 3,6 at the entrance	
Ø 5,0	2,0 2,4 2,8 3,2 3,6 4,0 4,4 at the entrance 4,8 at the entrance	2,0 2,4 2,8 3,2 3,6 4,0 4,4 4,8 at the entrance	2,0 2,4 2,8 3,2 3,6 4,0 at the entrance	2,0 2,4 2,8 3,2 3,6 4,0 at the entrance	<p>short Ø 5,0 L 6</p> <p>Start the osteotomy with standard twist drill Ø 2.0mm, Ø 2.4mm and Ø 2.8mm Complete with the Ø 5mm L 6 JDIcon Plus+ drill JDDICS5</p>

Note: all measurements in mm