



JDENTALCARE  
*just smile*

# SURGICAL AND PROSTHETIC MANUAL

Dental Implants



## GENERAL INFORMATION

The success of the treatment of patients is strictly connected to a proper planning of the surgery and to an appropriate choice of the type of dental implant to be used, based on the specific clinical case. JDentalCare offers a series of solutions to a wide range of indications, to allow the clinicians to perform the oral surgeries in order to obtain efficient results in terms of clinical outcomes and patient satisfaction. This manual contains the main stages of the surgical procedure and has been prepared with the aim to be used as a reference guide by dental implant specialists to optimize the use of JDentalCare implants, surgical instruments, and prosthetic components. Anyway, it cannot be used as a substitute for professional training and experience. Implant users must have knowledge of dental implantology and must follow what is written in this IFU and in the Surgical Manual, in order to use JDentalCare products appropriately and safely. It is responsibility of users to use the device in accordance with this IFU and to choose the suitable device for the specific clinical case. Although specific trainings are not required, JDentalCare offers a wide range of courses and medical trainings in the field of dental implantology. For further information please visit: [www.jdentalcare.com](http://www.jdentalcare.com)

**Note:** Some products manufactured by JDentalCare may not have been regulatory cleared/released for sale in all countries. For more information about current product assortment and availability, please contact your local JDentalCare distributor.

**Caution:** Federal law restricts this device to sale by or on the order of a licensed dentist or physician. The JDentalCare implant system has not been evaluated for safety and compatibility in the MR environment. It has not been tested for heating, migration, or image artifact in the MR environment. The safety of the JDentalCare implant system in the MR environment is unknown. Scanning a patient who has this device may result in patient injury.

## JDENTALCARE IMPLANTS

JDentalCare dental implants are endosseous implants intended for surgical placement in the upper or lower jaw. They are comprised of fixtures and prosthetic devices. JDentalCare implants act as a prosthetic anchorage in the rehabilitation of partial or total edentulism, in reconstruction with single-tooth and/or multiple teeth restorations, or as a terminal or support for fixed or removable bridges, hybrid prostheses or overdentures. Prosthetic devices provide support and retention for restorations in mandible and maxilla. JDentalCare implants can be placed either using a one-stage or a two-stage surgical technique with delayed, early or immediate loading protocol, in order to achieve good primary stability also in cases of atrophic maxilla. JDentalCare dental implants are intended for adult patients subject to dental implant treatment. JDentalCare dental implants are made of commercially pure, cold worked Titanium Grade 4 or Titanium Grade 5. Different sizes, designs of thread and collar, treated surfaces are available so that the dentist can choose the most appropriate solution for each clinical case. The implant lines considered in this manual are identified in the catalogue with the following names:

- JDNow
- JDEvolution
- JDEvolution Plus
- JDEvolution S
- JDIcon
- JDIcon Plus
- JDIcon Ultra S
- JDOcta
- JDNasal
- JDPterygo

The implants are available in the sizes shown in the tables below.

## JDEvolution

Note: all measurements in mm

IMPLANT DIAMETER	LENGTH	TIP DIAMETER	PLATFORM DIAMETER	ABUTMENT INTERFACE
Ø 3.7	8	2.8	3.7	3.4
	10, 11.5, 13, 15, 18	2.4		
Ø 4.3	6	3.82	4.0	3.4
	8, 10, 11.5, 13, 15, 18	2.8		
Ø 5.0	6	3.85	4.8	3.4
	8, 10, 11.5, 13, 15	3.2		
Ø 6.0	6	4.4	5.0	3.4
	8	4.1		
	10, 11.5, 13, 15	4		

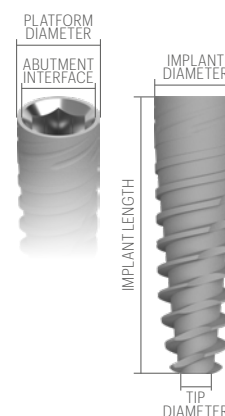

## JDEvolution Plus

Note: all measurements in mm

IMPLANT DIAMETER	LENGTH	TIP DIAMETER	PLATFORM DIAMETER	ABUTMENT INTERFACE
Ø 3.7	8	2.8	3.7	3.4
	10, 11.5, 13, 15, 18	2.4		
Ø 4.0	8	2.8	3.8	3.4
	10	2.5		
	11.5, 13	2.4		
Ø 4.3	6	3.82	4.0	3.4
	8	3.55		
	10, 11.5, 13, 15, 18	2.8		
Ø 5.0	6	3.85	4.8	3.4
	8, 10, 11.5, 13, 15	3.2		
Ø 6.0	6	4.4	5.0	3.4
	8	4.1		
	10, 11.5, 13, 15	4		

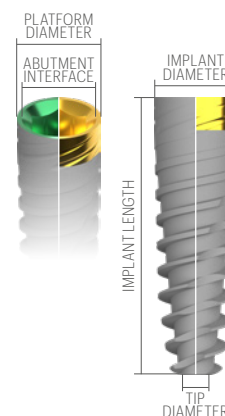

## JDEvolution Plus T

Note: all measurements in mm

IMPLANT DIAMETER	LENGTH	TIP DIAMETER	PLATFORM DIAMETER	ABUTMENT INTERFACE
Ø 4.0	6	2.6	3.8	3.4
	8, 10, 11.5, 13, 15, 18	2.4		

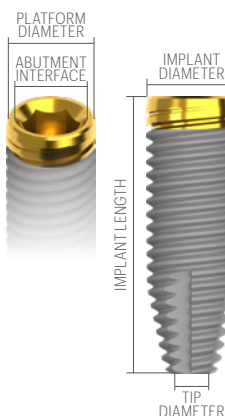

## JDEvolution S

Note: all measurements in mm

IMPLANT DIAMETER	LENGTH	TIP DIAMETER	PLATFORM DIAMETER	ABUTMENT INTERFACE
Ø 3,2	8	2.8	3.2	3.0
	10, 11.5, 13, 15	2.7		

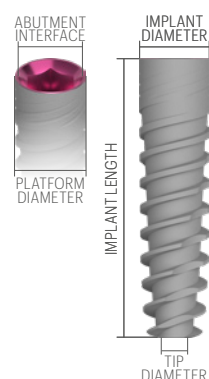

## JDIcon

Note: all measurements in mm

IMPLANT DIAMETER	LENGTH	TIP DIAMETER	PLATFORM DIAMETER	ABUTMENT INTERFACE
Ø 3,9	8	2.5	3.9	3.4
	10, 11.5	2.4		
	13, 15, 18, 20	2.8		
Ø 4,3	6, 8	3.25	4	3.4
	10, 11.5, 13, 15	2.8		
Ø 5,0	6, 8, 10, 11.5, 13, 15	3.2	4.7	3.4

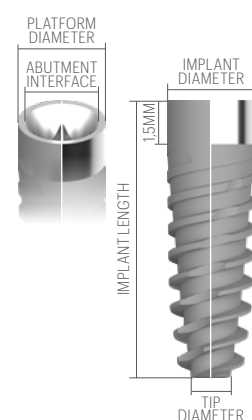

## JDIcon Plus

Note: all measurements in mm

IMPLANT DIAMETER	LENGTH	TIP DIAMETER	PLATFORM DIAMETER	ABUTMENT INTERFACE
Ø 3,7	8	2.8	3.7	3.1
	10, 11.5, 13, 15, 18	2.4		
Ø 4,3	6	2.4	3.8	3.1
	8	3.55	4	
	10, 11.5, 13, 15, 18	2.8		
Ø 5,0	6	2.8	4.7	3.1
	8	3.2	4.8	
	10, 11.5, 13			

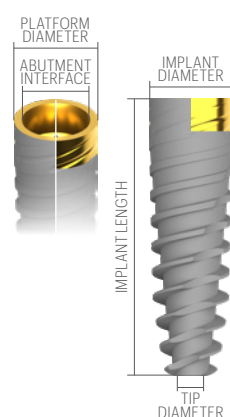

## JDIcon Ultra S

Note: all measurements in mm

IMPLANT DIAMETER	LENGTH	TIP DIAMETER	PLATFORM DIAMETER	ABUTMENT INTERFACE
Ø 2,75	8, 10, 11,5, 13, 15	1.95	2.75	2.3

Note: all measurements in mm

Cautions: JDIcon Ultra S implants are mostly recommended to replace maxillary lateral incisors and mandibular incisor and for single-unit restorations. For more information about the implant lines and all the compatible components and accessories, refer to JDentalCare catalogue, available at: [www.jdentalcare.com](http://www.jdentalcare.com).

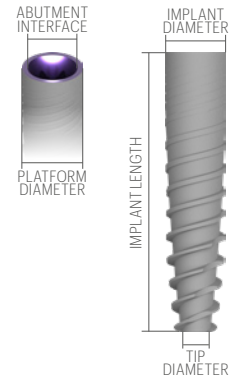

## JDIcon Plus T

Note: all measurements in mm

IMPLANT DIAMETER	LENGTH	TIP DIAMETER	PLATFORM DIAMETER	ABUTMENT INTERFACE
Ø 3,5	10, 11,5, 13	1.6	3.4	3.1
Ø 4,0	8.5	1.75	3.5	3.1
	10, 11,5, 13		3.6	
Ø 4,5	8.5, 10, 11,5, 13	1.75	3.6	3.1
Ø 5,0	8.5, 10, 11,5, 13	1.75	3.5	3.1
Ø 6,0	8.5, 10, 11.5	3	5.0	3.1

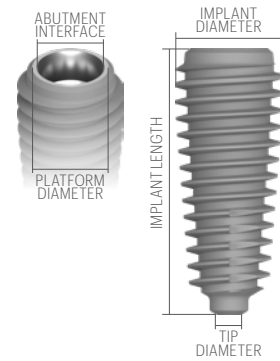

## JDNow

Note: all measurements in mm

IMPLANT DIAMETER	LENGTH	TIP DIAMETER
Ø 3,0	12, 14, 16, 18	1.5
Ø 3,5	10, 12, 14, 16, 18	1.65
Ø 4,2	10, 12, 14, 16, 18	2
Ø 4,2 (shoulder)	10, 12, 14, 16, 18	2
Ø 5,0	10, 12, 14, 16	2.4
Ø 5,0 (shoulder)	10, 12, 14, 16	2.4
Ø 6,0	10, 12, 14, 16	2.4
Ø 6,0 (shoulder)	10, 12, 14, 16	2.4

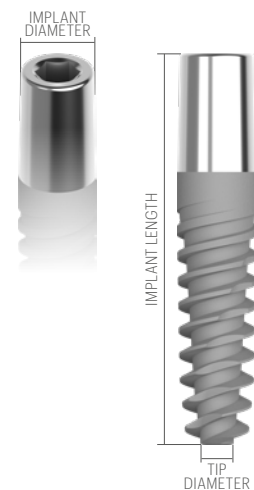

## JDOcta

Note: all measurements in mm

IMPLANT DIAMETER	LENGTH	TIP DIAMETER	PLATFORM DIAMETER	ABUTMENT INTERFACE
Ø 3,7	8	2.8	4.8	3.5
	10, 11.5	2.4		
Ø 4,3	8	3.55	4.8	2
	10, 11.5	2.8		
Ø 5,0	8	3.55	6.5	3.5
	10, 11.5	3.2		

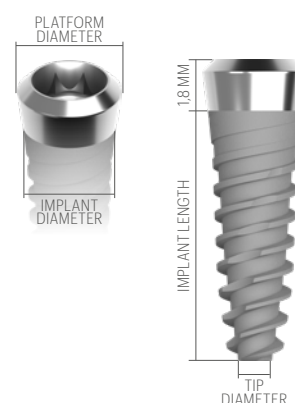

## JDPterygo

Note: all measurements in mm

IMPLANT DIAMETER	LENGTH	TIP DIAMETER	PLATFORM DIAMETER	ABUTMENT INTERFACE
Ø 3,3	13, 15, 18, 20	1.75	3.3	3.4
Ø 4,0	13, 15, 18, 20	2.4	4.0	3.4

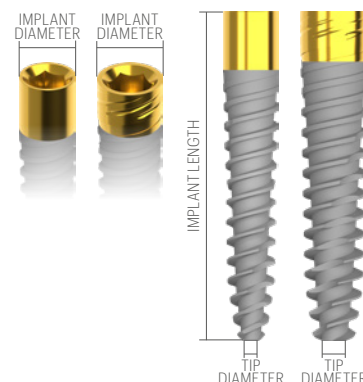

## JDNasal

Note: all measurements in mm

IMPLANT DIAMETER	LENGTH	TIP DIAMETER
Ø 4.1 (JDNasal)	20, 22, 24, 26	2.18
Ø 4.1 (JDNasal Evo)	18, 20, 22, 24, 26, 28, 30	2.4
Ø 4.1 (JDNasal T)	18, 20, 22, 24, 26,	2

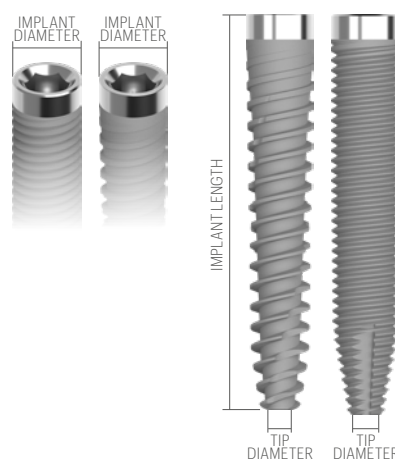

---

# ***SURGICAL PROCEDURE***

---

## PATIENT EVALUATION AND PREOPERATIVE PLANNING

An appropriate planning of every aspect of the oral surgery is essential for the long term success of a prosthesis. The preoperative planning should be made based on the expected aesthetic and functional restorative results. The choice of unsuitable sizes of the devices and the malposition of the implant may lead to complications, undesirable effects and to the failure of treatment. To avoid this, a detailed examination through clinical and radiographic analysis of the patient general health condition and current medical status, and an evaluation of patient motivations and expectations are necessary. Moreover, factors such as cigarette smoking, masticatory function and alcohol consumption are to be considered. Dental casts can be used to define the position and angulation of implants. The dentist will develop the plan after gathering all the required data, because they provide important information and make possible a backward planning, with the aim to improve the safety and the results of the surgical procedure.

---

## QUALITY AND QUANTITY OF THE BONE

The implant diameter, type and position are all factors that should be selected in each single case, based on the oral anatomy of the patient and taking into account of all the above mentioned considerations about patient's psychological and physiological condition. One of the main factors to consider for the definition of the protocol for the preparation of the implant site is the evaluation of the density, the volume and the thickness of the bone, which are features that differ from patient to patient and in a single individual from one area of the mouth to another. Usually, dense cortical bone provides higher primary stability, while soft bone requires "under preparation" of the implant bed. The choice of the length of the implant to use is influenced by the height of the available vertical bone. The amount of bone is not the same in all the sites. The available bone may be situated in the most apical section of the implant, as it happens in a post extraction site, or at the neck section of the implant, as in cases of maxillary sinus elevation procedure. After placement of the implant the thickness of the residual bone needs to be at least 1.5 mm, in both lingual palatal and vestibular direction, in order to avoid the risk of gingival margin recession. The special reduction in the coronal section of the implant makes it ideal for cases with thin alveolar ridges. The flapless technique can be used when there is an optimal quantity of bone and soft tissue. In some cases, the mass of the jaw is not suitable to insert a dental implant and an intervention of bone augmentation may be necessary. Moreover, JDentalCare provides narrow diameter implants, that can be used as a minimally invasive alternative to bone augmentation and as an evaluable solution in patients with insufficient bone ridge thickness or restricted mesiodistal anatomy. Important: examination and a radiological study are essential elements to determine anatomical conformation, occlusion, periodontal status and bone thickness. A "Cone Beam CT" radiological study is recommended to obtain a more precise evaluation of the dimension and quality of the available bone.

### **Bone Density Classification**

Various classifications of bone density have been proposed in literature. Lekholm and Zarb<sup>1</sup> classified bone density into four bone types based on the amount of cortical and trabecular bone.

**Type 1:** homogenous compact bone,

**Type 2:** thick layer of compact bone surrounding a core of dense trabecular bone.

**Type 3:** thin layer of cortical bone surrounding a core of dense trabecular bone.

**Type 4:** thin layer of cortical bone surrounding a core of low density trabecular bone.

Bones of different densities may resist differently when preparing the implant site and inserting the implant. In this manual are proposed protocols with drilling sequences based on bone density (see the next paragraph). It is the



doctor's responsibility to assess bone density and adopt the appropriate protocol.



Type 1

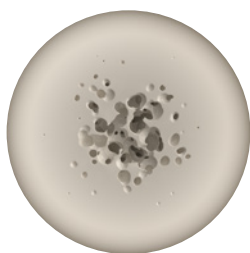

Type 2

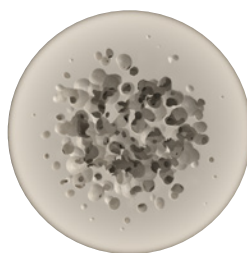

Type 3

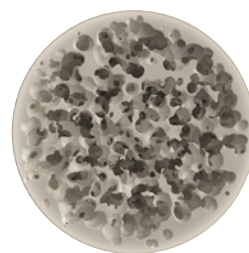

Type 4

*1 Lekholm U., Zarb G.A. Patient selection and preparation. In: Brånemark P. I., Zarb G.A., Albrektsson T., editors. Tissue integrated Prostheses: Osseointegration in Clinical Dentistry. Quintessence; Chicago: 1985. pp. 199–209.*

## SURGICAL PROCEDURE STEP BY STEP

### 1. Initial drilling

#### **Flapless procedure**

Drill to the appropriate depth using the  $\varnothing$  1.5mm precision drill that has a cutting edge that allows its use even in dense bone. Be careful not to drill for a depth greater than that of the selected implants. **The speed of the drill must not exceed 1200 rpm.**

*Note: When operating flapless, always measure the thickness of the soft tissue with a probe, for a correct preparation of the osteotomy to the desired depth.*

Insert the direction guide for the tissue punch corresponding to the diameter of the selected implant in the  $\varnothing$  1.5mm hole. Connect the tissue punch to the contra-angle and position it on the guide. Incise into tissue until reaching the osseous crest. **The speed of the tissue punch must not exceed 800 rpm.**

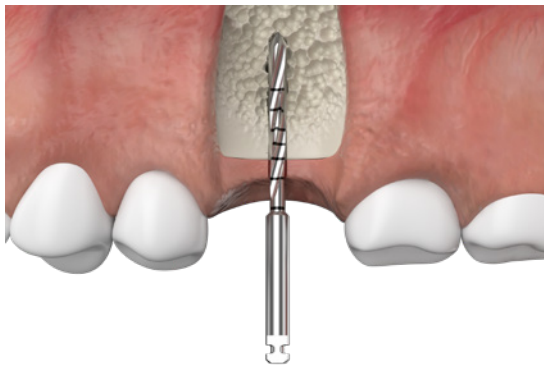

#### **Flap procedure**

In case of flap procedure, use a normal or small scalpel to make an incision, and rise a flap. Once the gingiva has been opened, the implantation site shall be prepared. For this purpose, use the  $\varnothing$  1.5 mm that has a cutting edge that allows its use even in dense bone. Be careful not to drill for a depth greater than that of the selected implants. **The maximum speed for the precision drill must not exceed 1200 rpm.**



**Flapless surgery with tissue punch**

Insert the direction guide for the tissue punch corresponding to the diameter of the selected implant in the Ø1.5mm hole. Connect the tissue punch to the contra-angle and position it on the guide. Incise into tissue until reaching the osseous crest.

The speed of the tissue punch must not exceed 800 rpm.

Use a normal or small scalpel to incise erpendicularly along the outline of the soft tissue so as to free it and remove it from the top of the crest.

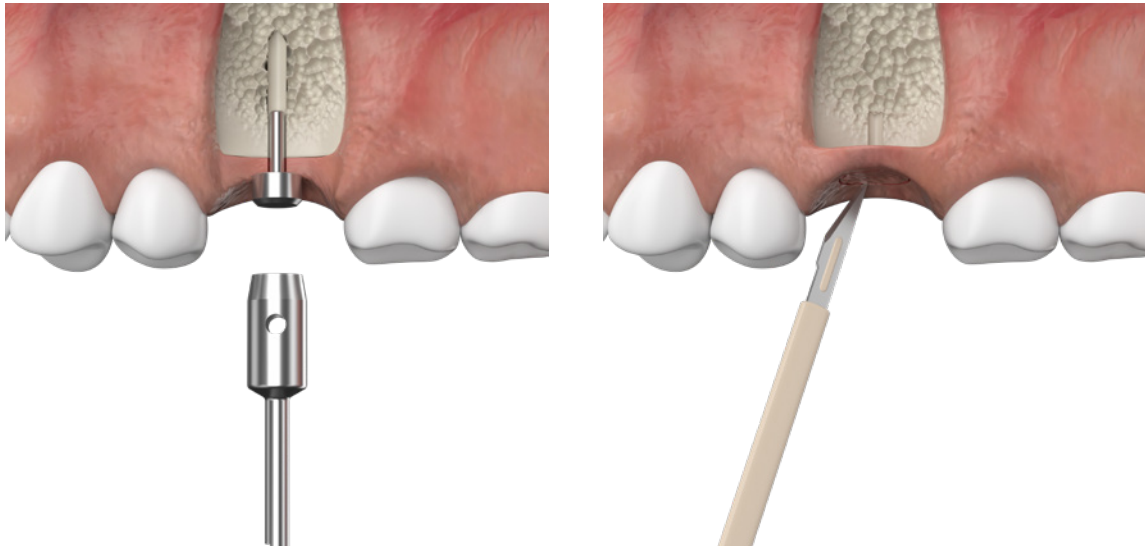

**2. Drilling with Ø 2 drill**

Continue with the preparation of the osteotomy using the Ø 2.0 drill.

The maximum speed of the drill must not exceed 1200 rpm.

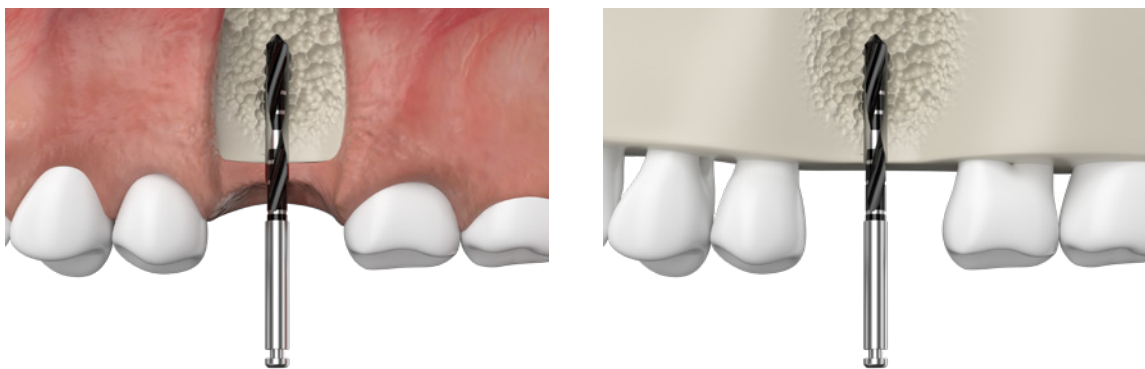

**FLAPLESS**

**WITH FLAP**

**3. Check of drilling direction**

You can control the direction of the drilling at any time, using the direction indicator. The direction indicators are provided of notches to measure the depth of the implant site. You may need a radiological examination to verify parallelism with other pieces or adjacent implants. If necessary, correct the direction of the drilling. When placing multiple implants, proceed with the same drill for all the osteotomies before moving to the next drill planned in the sequence.

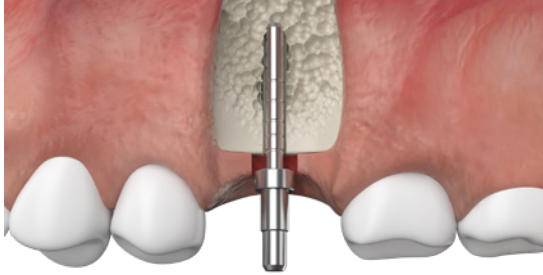

*FLAPLESS*

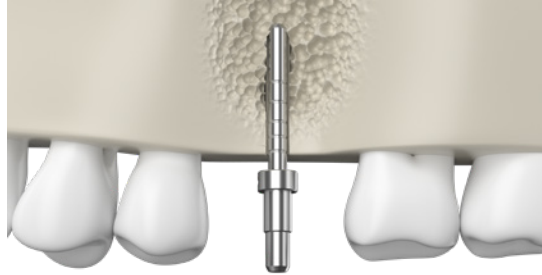

*WITH FLAP*

**4. Drilling with drills with diameter from 2.4/2.8mm upwards**

To continue with the preparation, use drills with diameter from 2.4/2.8 mm upwards. The maximum speed of the drill must not exceed 1200 rpm.



*FLAPLESS*

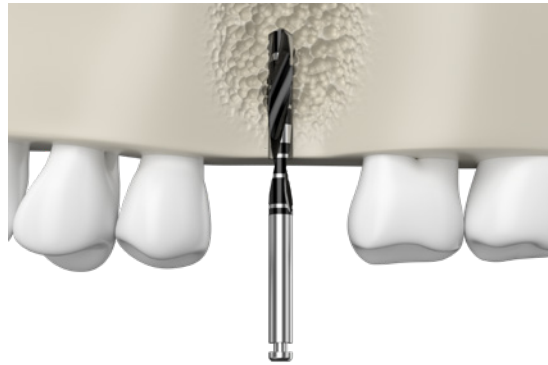

*WITH FLAP*

Measure the depth of the drilling and control the integrity of the cortical walls in the prepared cavity using a probe.



*FLAPLESS*

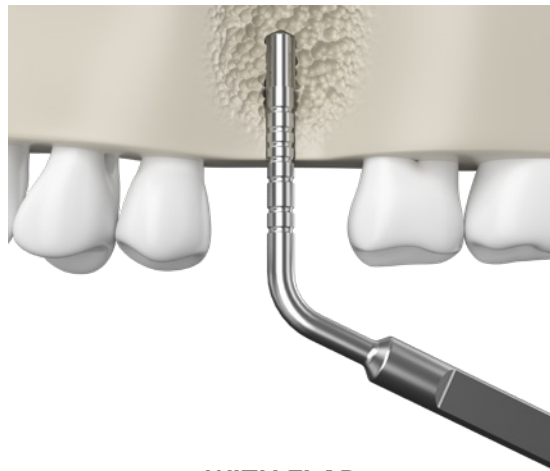

*WITH FLAP*

**Drill Stop**

The drill stop enables dentists to control the depth of the implant site, during the drilling procedure. For a safe and accurate drilling procedure, mount the Drill Stop on the drill.

---

## DRILLING SEQUENCE

JDentalCare offers a set of drills that have been designed in order to perform the flapless and the conventional flapless dental implant surgery. To perform flapless surgery, the tissue punch with a guide has been introduced to incise soft tissue until reaching the osseous crest.

All drilling in the bone should be performed at a maximum of 1200 rpm. Before to start, verify that the drill is engaged/retained in the handpiece, in order to avoid an accidental detachment during the surgery. To prevent damages to hard and soft tissues and to prevent the overheating of the bone an intermittent drilling technique with pumping motion and a plentiful irrigation with sterile water or saline solution are required. It's recommended during the procedure to take out the drill completely from the site, to check that irrigation is taking place correctly. Stop drilling if there is no irrigation. When pulling out the drill, don't stop the motor, in order to allow the irrigation to remove debris. On the drill there are laser marks that serve as a reference of the depth of the hole to be executed, hence stop drilling when the desired depth is reached. If there are adjacent natural teeth interfering with the head of the contra angle, the drill extension shall be used. It is advisable to use surgical motors with adjustable speed and torque. All the reusable instruments are delivered non sterile and must be sterilized prior to use.

For information about the resterilization protocol, see the section "Sterility information for surgical instruments and kits". They can be used for a maximum of 30 times, or should be substituted before if the cutting efficiency degrades significantly. It is recommended to adhere to the indication of the drilling sequence related to the quality of bone and implant diameters that have been specified in the following tables, for each implant line, in order to achieve a good primary stability of the implant. Pay attention to not over prepare the osteotomy with a depth greater than that defined in the planning stage.

**General note:** Where not specified, all the drills diameters reported in the tables below refer to the corresponding twist drills diameters. Drilling depth is determined by the length of the implant to be inserted and is controlled through the depth marks on the drills or through the drill stops (in case of the twist drills with stops) All the dimensions in the tables below are expressed in millimeters.

# JDEvolution, JDEvolution Plus

IMPLANT DIAMETER	HEALED BONE		POST EXTRACTIVE BONE		SHORT IMPLANTS L 6mm
	SOFT BONE	MEDIUM-DENSE BONE	SOFT BONE	MEDIUM-DENSE BONE	
<b>Site preparation in maxilla</b>					
<b>Ø 3,7</b>	2,0 2,4 2,8 up to the 1 <sup>st</sup> laser mark L6mm	2,0 2,4 2,8 3,2 up to the 1 <sup>st</sup> laser mark L6mm	2,0 2,4 2,8 at the entrance	2,0 2,4 2,8 at the entrance	/
<b>Ø 4,3</b>	2,0 2,4 2,8 3,2 at the entrance	2,0 2,4 2,8 3,2 up to the 1 <sup>st</sup> laser mark L6-8mm 3,6 at the entrance	2,0 2,4 2,8 3,2 at the entrance	2,0 2,4 2,8 3,2 at the entrance	- Start the osteotomy with standard twist drill Ø 2.0mm and Ø 2.4mm - Complete with the Ø 4mm L 6mm drill code JDDICS4
<b>Ø 5,0</b>	2,0 2,4 2,8 3,2 3,6 up to the 1 <sup>st</sup> laser mark L 6mm	2,0 2,4 2,8 3,2 3,6 up to the 1 <sup>st</sup> laser mark L 6mm 4,0 at the entrance	2,0 2,4 2,8 3,2 3,6 at the entrance up to the 1 <sup>st</sup> laser mark L 6mm	2,0 2,4 2,8 3,2 3,6 at the entrance up to the 1 <sup>st</sup> laser mark L 6mm	- Start the osteotomy with standard twist drill Ø 2.0mm and Ø 2.4mm - Complete with the Ø 4mm L 6mm drill code JDDICS4D
<b>Ø 6,0</b>	2,0 2,4 2,8 3,2 3,6	2,0 2,4 2,8 3,2 3,6 4,0 4,4 up to the 1 <sup>st</sup> laser mark L 6mm	2,0 2,4 2,8 3,2 3,6 4,0	2,0 2,4 2,8 3,2 3,6 4,0	/
<b>Site preparation in mandible</b>					
<b>Ø 3,7</b>	2,0 2,4 2,8 3,2 up to the 2 <sup>nd</sup> laser mark L 8mm 3,6 up to the 1 <sup>st</sup> laser mark L 6mm	2,0 2,4 2,8 3,2 3,6 up to the 1 <sup>st</sup> laser mark L 6mm	2,0 2,4 2,8 3,2 at the entrance	2,0 2,4 2,8 3,2 at the entrance	/
<b>Ø 4,3</b>	2,0 2,4 2,8 3,2 3,6 up to the 2 <sup>nd</sup> laser mark L 8mm 4,0 up to the 2 <sup>nd</sup> laser mark L 8mm	2,0 2,4 2,8 3,2 3,6 4,0 up to the 2 <sup>nd</sup> laser mark L8mm 4,4 up to the 1 <sup>st</sup> laser mark L 6mm	2,0 2,4 2,8 3,2 3,6 at the entrance	2,0 2,4 2,8 3,2 3,6 at the entrance	- Start the osteotomy with standard twist drill Ø 2.0mm, Ø 2,4mm and Ø 2,8mm. - Complete with the Ø 4mm L 6mm drill code JDDICS4D
<b>Ø 5,0</b>	2,0 2,4 2,8 3,2 3,6 4,0 4,4 up to the 2 <sup>nd</sup> laser mark L 8mm 4,8 at the entrance	2,0 2,4 2,8 3,2 3,6 4,0 4,4 4,8 at the entrance	2,0 2,4 2,8 3,2 3,6 4,0 at the entrance	2,0 2,4 2,8 3,2 3,6 4,0 at the entrance	- Start the osteotomy with standard twist drill Ø 2,0mm, Ø 2,4mm and Ø 2,8mm. - Complete with the Ø 5mm L 6mm drill code JDDICS5
<b>Ø 6,0</b>	2,0 2,4 2,8 3,2 3,6 4,0 4,4 up to the 2 <sup>nd</sup> laser mark L 8mm 4,8 up to the 2 <sup>nd</sup> laser mark L 8mm	2,0 2,4 2,8 3,2 3,6 4,0 4,4 4,8 up to the 2 <sup>nd</sup> laser mark L 8mm	2,0 2,4 2,8 3,2 3,6 4,0 4,4	2,0 2,4 2,8 3,2 3,6 4,0 4,4	/

## Ø 4,0 Implants

	HEALED BONE		POST EXTRACTIVE BONE		SHORT IMPLANTS L 6mm
IMPLANT DIAMETER	SOFT BONE	MEDIUM-DENSE BONE	SOFT BONE	MEDIUM-DENSE BONE	
<b>Site preparation in maxilla</b>					
Ø 4,0	2.0 2.4 2.8	2.0 2.4 2.8 3.2 up to the 2 <sup>nd</sup> laser mark L 8mm	2.0 2.4 2.8 up to the 2 <sup>nd</sup> laser mark L 8mm	2.0 2.4 2.8	- Start the osteotomy with standard twist drill Ø 2.0mm and Ø 2.4mm - Complete with the Ø 4mm L 6mm drill code JDDICS4
<b>Site preparation in mandible</b>					
Ø 4,0	2.0 2.4 2.8 3.2 up to the 2 <sup>nd</sup> laser mark L 8mm 3.6 up to the 2 <sup>nd</sup> laser mark L 8mm	2.0 2.4 2.8 3.2 3.6 4.0 up to the 1 <sup>st</sup> laser mark L 6mm	2.0 2.4 2.8 3.2 up to the 2 <sup>nd</sup> laser mark L 8mm 3.6 up to the 2 <sup>nd</sup> laser mark L 8mm	2.0 2.4 2.8 3.2 3.6 up to the 2 <sup>nd</sup> laser mark L 8mm	- Start the osteotomy with standard twist drill Ø 2.0mm, Ø 2.4mm and Ø 2.8mm - Complete with the Ø 4mm L 6mm drill code JDDICS4D

## JDEvolution S

IMPLANT DIAMETER	SOFT BONE TYPE IV	MEDIUM BONE TYPE II-III	DENSE BONE TYPE I
Ø 3,2	1,5 (2)	2 2,4	2 2,4 (2,8)



# JDIcon

	HEALED BONE		POST EXTRACTIVE BONE		SHORT IMPLANTS L 6mm
IMPLANT DIAMETER	SOFT BONE	MEDIUM-DENSE BONE	SOFT BONE	MEDIUM-DENSE BONE	
<b>Site preparation in maxilla</b>					
<b>Ø 3,9</b>	2,0 2,4 2,8 up to the 1 <sup>st</sup> laser mark L6mm	2,0 2,4 2,8 3,2 up to the 1 <sup>st</sup> laser mark L6mm	2,0 2,4 2,8 at the entrance	2,0 2,4 2,8 at the entrance	/
<b>Ø 4,3</b>	2,0 2,4 2,8 3,2 at the entrance	2,0 2,4 2,8 3,2 up to the 1 <sup>st</sup> laser mark L6-8mm 3,6 at the entrance	2,0 2,4 2,8 3,2 at the entrance	2,0 2,4 2,8 3,2 at the entrance	- Start the osteotomy with standard twist drill Ø 2,0mm and Ø 2,4mm - Complete with the Ø 4mm L 6mm drill code JDDICS4
<b>Ø 5,0</b>	2,0 2,4 2,8 3,2 3,6 up to the 1 <sup>st</sup> laser mark L 6mm	2,0 2,4 2,8 3,2 3,6 up to the 1 <sup>st</sup> laser mark L 6mm 4,0 at the entrance	2,0 2,4 2,8 3,2 3,6 at the entrance up to the 1 <sup>st</sup> laser mark L 6mm	2,0 2,4 2,8 3,2 3,6 at the entrance up to the 1 <sup>st</sup> laser mark L 6mm	- Start the osteotomy with standard twist drill Ø 2,0mm and Ø 2,4mm - Complete with the Ø 4mm L 6mm drill code JDDICS4D
<b>Site preparation in mandible</b>					
<b>Ø 3,9</b>	2,0 2,4 2,8 3,2 up to the 2 <sup>nd</sup> laser mark L 8mm 3,6 up to the 1 <sup>st</sup> laser mark L 6mm	2,0 2,4 2,8 3,2 3,6 up to the 1 <sup>st</sup> laser mark L 6mm	2,0 2,4 2,8 3,2 at the entrance	2,0 2,4 2,8 3,2 at the entrance	/
<b>Ø 4,3</b>	2,0 2,4 2,8 3,2 3,6 up to the 2 <sup>nd</sup> laser mark L 8mm 4,0 up to the 2 <sup>nd</sup> laser mark L 8mm	2,0 2,4 2,8 3,2 3,6 4,0 up to the 2 <sup>nd</sup> laser mark L8mm 4,4 up to the 1 <sup>st</sup> laser mark L 6mm	2,0 2,4 2,8 3,2 3,6 at the entrance	2,0 2,4 2,8 3,2 3,6 at the entrance	- Start the osteotomy with standard twist drill Ø 2,0mm, Ø 2,4mm and Ø 2,8mm. - Complete with the Ø 4mm L 6mm drill code JDDICS4D
<b>Ø 5,0</b>	2,0 2,4 2,8 3,2 3,6 4,0 4,4 up to the 2 <sup>nd</sup> laser mark L 8mm 4,8 at the entrance	2,0 2,4 2,8 3,2 3,6 4,0 4,4 4,8 at the entrance	2,0 2,4 2,8 3,2 3,6 4,0 at the entrance	2,0 2,4 2,8 3,2 3,6 4,0 at the entrance	- Start the osteotomy with standard twist drill Ø 2,0mm, Ø 2,4mm and Ø 2,8mm. - Complete with the Ø 5mm L 6mm drill code JDDICS5

# JDIcon Ultra S

IMPLANT DIAMETER	SOFT BONE TYPE IV	MEDIUM BONE TYPE II-III	DENSE BONE TYPE I
<b>Ø 2,75</b>	1,5 2,0	2,0 2,4	2,0 2,4 2,8*

# JDIcon Plus

	HEALED BONE		POST EXTRACTIVE BONE		SHORT IMPLANTS L 6mm
IMPLANT DIAMETER	SOFT BONE	MEDIUM-DENSE BONE	SOFT BONE	MEDIUM-DENSE BONE	
<b>Site preparation in maxilla</b>					
<b>Ø 3,7</b>	2,0 2,4 2,8 up to the 1 <sup>st</sup> laser mark L 6mm	2,0 2,4 2,8 3,2 up to the 1 <sup>st</sup> laser mark L 6mm	2,0 2,4 2,8 at the entrance	2,0 2,4 2,8 at the entrance	
<b>Ø 4,3</b>	2,0 2,4 2,8 3,2 at the entrance	2,0 2,4 2,8 3,2 up to the 1 <sup>st</sup> laser mark L 6-8mm 3,6 at the entrance	2,0 2,4 2,8 3,2 at the entrance	2,0 2,4 2,8 3,2 at the entrance	Use the Ø 4mm L6 JDIcon Plus+ drill JDDICS4
<b>Ø 5,0</b>	2,0 2,4 2,8 3,2 3,6 up to the 1 <sup>st</sup> laser mark L 6mm	2,0 2,4 2,8 3,2 3,6 up to the 1 <sup>st</sup> laser mark L 6mm 4,0 at the entrance	2,0 2,4 2,8 3,2 3,6 at the entrance up to the 1 <sup>st</sup> laser mark L 6mm	2,0 2,4 2,8 3,2 3,6 at the entrance up to the 1 <sup>st</sup> laser mark L 6mm	Use the Ø 4mm L6 JDIcon Plus+ drill JDDICS4D
<b>Site preparation in mandible</b>					
<b>Ø 3,7</b>	2,0 2,4 2,8 3,2 at the entrance 3,6 at the entrance up to the 1 <sup>st</sup> laser mark L6mm	2,0 2,4 2,8 3,2 3,6 up to the 1 <sup>st</sup> laser mark L 6mm	2,0 2,4 2,8 3,2 at the entrance	2,0 2,4 2,8 3,2 at the entrance	
<b>Ø 4,3</b>	2,0 2,4 2,8 3,2 3,6 at the entrance 4,0 at the entrance up to the 2 <sup>nd</sup> laser mark L8mm	2,0 2,4 2,8 3,2 3,6 4,0 up to the 2 <sup>nd</sup> laser mark L8mm 4,4 up to the 1 <sup>st</sup> laser mark L 6mm	2,0 2,4 2,8 3,2 3,6 at the entrance	2,0 2,4 2,8 3,2 3,6 at the entrance	- Start the osteotomy with standard twist drill Ø 2,0mm, Ø 2,4mm and Ø 2,8mm. - Complete with the Ø 4mm L6 JDIcon Plus+ drill JDDICS4D
<b>Ø 5,0</b>	2,0 2,4 2,8 3,2 3,6 4,0 4,4 at the entrance 4,8 at the entrance	2,0 2,4 2,8 3,2 3,6 4,0 4,4 4,8 at the entrance	2,0 2,4 2,8 3,2 3,6 4,0 at the entrance	2,0 2,4 2,8 3,2 3,6 4,0 at the entrance	- Start the osteotomy with standard twist drill Ø 2,0mm, Ø 2,4mm and Ø 2,8mm. - Complete with the Ø 5mm L 6 JDIcon Plus+ drill JDDICS5

# JDIcon Plus T

	HEALED BONE		POST EXTRACTIVE BONE	
IMPLANT DIAMETER	SOFT BONE	MEDIUM-DENSE BONE	SOFT BONE	MEDIUM-DENSE BONE
<b>Site preparation in maxilla</b>				
<b>Ø 3,5</b>	2,0 2,4 2,8 up to the 1 <sup>st</sup> laser mark L 6mm	2,0 2,4 2,8 3,2 up to the 1 <sup>st</sup> laser mark L 6mm	2,0 2,4 2,8 3,2 up to the 1 <sup>st</sup> laser mark L 6mm	2,0 2,4 2,8 at the entrance
<b>Ø 4,0</b>	2,0 2,4 2,8 3,2 at the entrance	2,0 2,4 2,8 3,2 up to the 1 <sup>st</sup> laser mark L 6-8mm 3,6 at the entrance	2,0 2,4 2,8 3,2 at the entrance	2,0 2,4 2,8 3,2 at the entrance
<b>Ø 4,5</b>	2,0 2,4 2,8 3,2 3,6 up to the 1 <sup>st</sup> laser mark L 6mm	2,0 2,4 2,8 3,2 3,6 up to the 1 <sup>st</sup> laser mark L 6mm 4,0 at the entrance	2,0 2,4 2,8 3,2 3,6 at the entrance up to the 1 <sup>st</sup> laser mark L 6mm	2,0 2,4 2,8 3,2 3,6 at the entrance up to the 1 <sup>st</sup> laser mark L 6mm
<b>Ø 5,0</b>	2,0 2,4 2,8 3,2 3,6 4,0 at the entrance	2,0 2,4 2,8 3,2 3,6 4,0 up to the 1 <sup>st</sup> laser mark L 6mm 4,8 at the entrance	2,0 2,4 2,8 3,2 3,6 at the entrance	2,0 2,4 2,8 3,2 3,6 up to the 1 <sup>st</sup> laser mark L 6mm 4,0 at the entrance
<b>Ø 6,0</b>	2,0 2,4 2,8 3,2 3,6 4,0 4,8 up to the 1 <sup>st</sup> laser mark L 6mm	2,0 2,4 2,8 3,2 3,6 4,0 4,8 up to the 1 <sup>st</sup> laser mark L 6mm	2,0 2,4 2,8 3,2 3,6 4,8 at the entrance	2,0 2,4 2,8 3,2 3,6 4,0 at the entrance 4,8 up to the 1 <sup>st</sup> laser mark L 6mm
<b>Site preparation in mandible</b>				
<b>Ø 3,5</b>	2,0 2,4 2,8 3,2 up to the 1 <sup>st</sup> laser mark L 6mm	2,0 2,4 2,8 3,2 up to the 2 <sup>nd</sup> laser mark L 8mm 3,6 up to the 1 <sup>st</sup> laser mark L 6mm	2,0 2,4 2,8	2,0 2,4 2,8 3,2 at the entrance
<b>Ø 4,0</b>	2,0 2,4 2,8 3,2 3,6 up to the 2 <sup>nd</sup> laser mark L 8mm	2,0 2,4 2,8 3,2 3,6 4,0 up to the 2 <sup>nd</sup> laser mark L 8mm 4,4 up to the 1 <sup>st</sup> laser mark L 6mm	2,0 2,4 2,8 3,2 at the entrance	2,0 2,4 2,8 3,2 3,6 at the entrance
<b>Ø 4,5</b>	2,0 2,4 2,8 3,2 3,6 at the entrance 4,0 at the entrance	2,0 2,4 2,8 3,2 3,6 4,0 4,4 4,8 at the entrance	2,0 2,4 2,8 3,2 3,6 at the entrance	2,0 2,4 2,8 3,2 3,6 4,0 at the entrance
<b>Ø 5,0</b>	2,0 2,4 2,8 3,2 3,6 at the entrance 4,0 at the entrance	2,0 2,4 2,8 3,2 3,6 4,0 4,4 4,8 at the entrance	2,0 2,4 2,8 3,2 3,6 at the entrance	2,0 2,4 2,8 3,2 3,6 4,0 at the entrance
<b>Ø 6,0</b>	2,0 2,4 2,8 3,2 3,6 4,0 4,8 at the entrance	2,0 2,4 2,8 3,2 3,6 4,0 4,4 4,8	2,0 2,4 2,8 3,2 3,6 4,8 at the entrance	2,0 2,4 2,8 3,2 3,6 4,0 4,8 up to the 1 <sup>st</sup> laser mark L 6mm

## JDOcta

IMPLANT DIAMETER	SOFT BONE TYPE IV	MEDIUM BONE TYPE II-III	DENSE BONE TYPE I
Ø 3,7	2,0 2,4	2,0 2,4 2,8	2,0 2,4 2,8 3,2 (3,6)
Ø 4,3	2,0 2,4 2,8	2,0 2,4 2,8 3,2 (3,6)	2,0 2,4 2,8 3,2 3,6 (4,0)
Ø 5,0	2,0 2,4 2,8 3,2	2,0 2,4 2,8 3,2 3,6 (4,0)	2,0 2,4 2,8 3,2 3,6 4,0 (4,4)

## JDNow

IMPLANT DIAMETER	SOFT BONE TYPE IV	MEDIUM BONE TYPE II-III	DENSE BONE TYPE I
Ø 3,0	2,0	2,0	2,0 2,4
Ø 3,5	2,0 2,4	2,0 2,4 (2,8)	2,0 2,4 2,8
Ø 4,2	2,0 2,4 2,8	2,0 2,4 2,8 3,2	2,0 2,4 2,8 3,2 (3,6)
Ø 5,0	2,0 2,4 2,8 3,2	2,0 2,4 2,8 3,2 3,6	2,0 2,4 2,8 3,2 3,6 4,0
Ø 6,0	2,0 2,4 2,8 3,2 3,6	2,0 2,4 2,8 3,2 3,6 4,0	2,0 2,4 2,8 3,2 3,6 4,0 4,4

## JD BONE TRACK DRILLS

JD Bone Track Drills are used for the post extractive implant insertion in cases where it is necessary to correct the orientation of osteotomy in order to insert the implant with the correct vestibular orientation. They are characterized by a diamond cutting body and a non-cutting tip. They are available in four different implant diameters (Ø3.2, Ø3.7, Ø4.3, Ø5.0 mm).

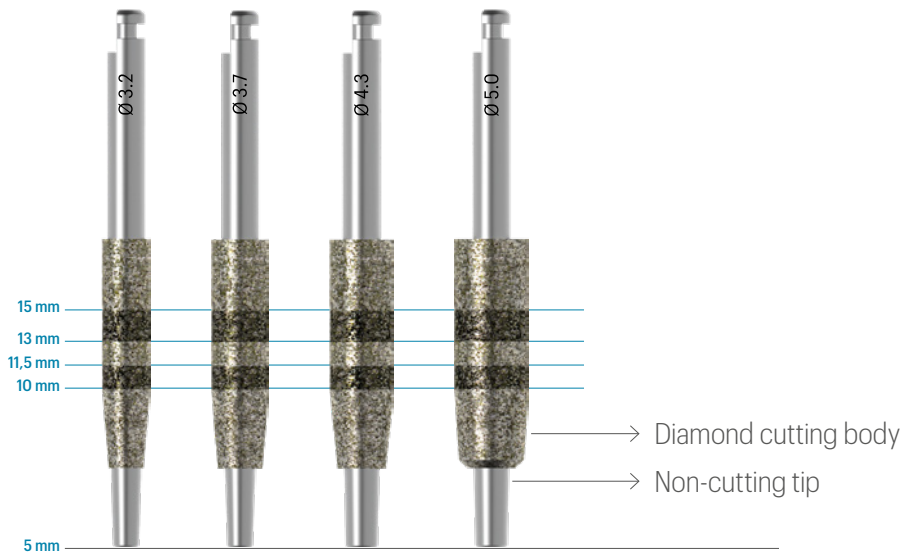

**Note:** all dimension are expressed in millimeters

### How to use:

- **Step 1:** Identify the anatomy of the socket and start drilling towards the palatal bone.  
*N.B.: The last standard drill diameter to be used for under-prepare the osteotomy always corresponds to the implant tip diameter to be inserted.*
- **Step 2:** Insert the non-cutting tip of the JD Bone Track Drill into the osteotomy and push the drill palatally in order to create a track on the palatal bone.
- **Step 3:** Insert the implant leaving the correct vestibular gap.

Recommended speed: 1500 rpm.

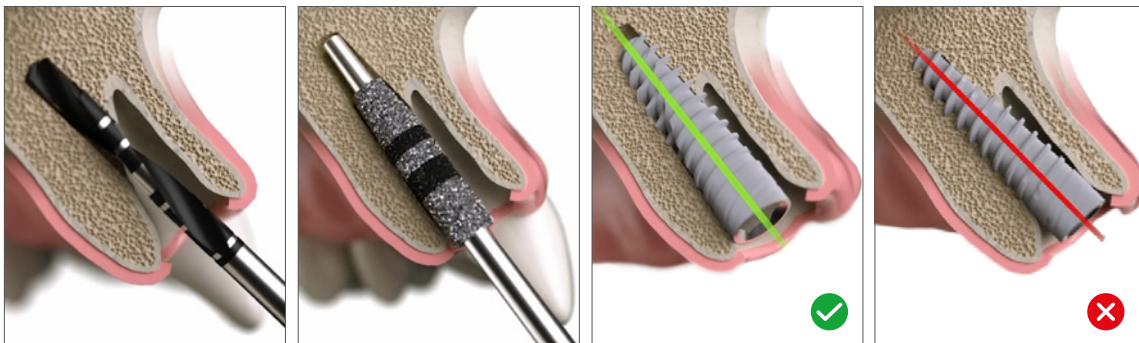

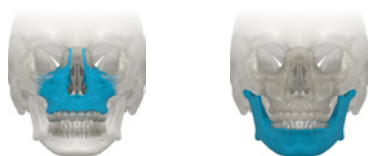

IMPLANT DIAMETER	PREPARATION IN MAXILLA	PREPARATION IN MANDIBLE
Ø 3,2	1.5 2.0 2.4 JD BoneTrack Drill 3.2	1.5 2.0 2.4 2.8 JD BoneTrack Drill 3.2
Ø 3,7	1.5 2.0 2.4 JD BoneTrack Drill 3.7	1.5 2.0 2.4 2.8 JD BoneTrack Drill 3.7
Ø 4,3	1.5 2.0 2.4 2.8 JD BoneTrack Drill 4.3	1.5 2.0 2.4 2.8 3.2 JD BoneTrack Drill 4.3
Ø 5,0	1.5 2.0 2.4 2.8 3.2 JD BoneTrack Drill 5.0	1.5 2.0 2.4 2.8 3.2 3.6 JD BoneTrack Drill 5.0

## JDONEDRILL

The JD Onedrill Kit is composed with 5 drills that allows you to simplify the drilling sequence. Use just one drill to create the implant site in case of soft or medium bone (Type III-IV), or two sequential drills in case of dense bone (Type I-II). The drills of the JD Onedrill Kit are used to prepare the osteotomy for placement of JDEvolution and JDEvolution S implants.

The drills of JD Onedrill kit are specially designed tapered with four blades edges. They simplify the drilling sequence, reducing the operation time and the post operative morbidity. These drills are available for four different diameters implants (3.2, 3.7, 4.3 and 5mm) characterized by different color codes. The maximum rotation speed indicated is 1200 rpm and cooling is obtained by copious irrigation with physiological solution. The drills of the JD Onedrill Kit cut efficiently; reducing the downward force will allow the drill to cut without detectable chatter. Do not pump the shaping drills as you might do with a twist drill when creating the osteotomy as it may distort the dimensions of the osteotomy. The shaping drill should be advanced once to full depth, then removed without any pumping action.

**Important:** When placing a JDEvolution implant in the bone (Type IV) the surgeon should consider undersizing the osteotomy. The final drill diameter should be limited to the one immediately smaller than the diameter that should have been used. When placing a JDEvolution implant in hard bone (Type I) do not underprepare the osteotomy site. The surgeon should consider to use as final drill diameter the one immediately bigger than the diameter that should have been used, stopping at the first laser mark. This will create an osteotomy of proper dimension in the dense cortical bone without any underpreparation.

A colored band indicating the diameter of the implant associated is applied exclusively on the drills of the JDOnedrill kit.

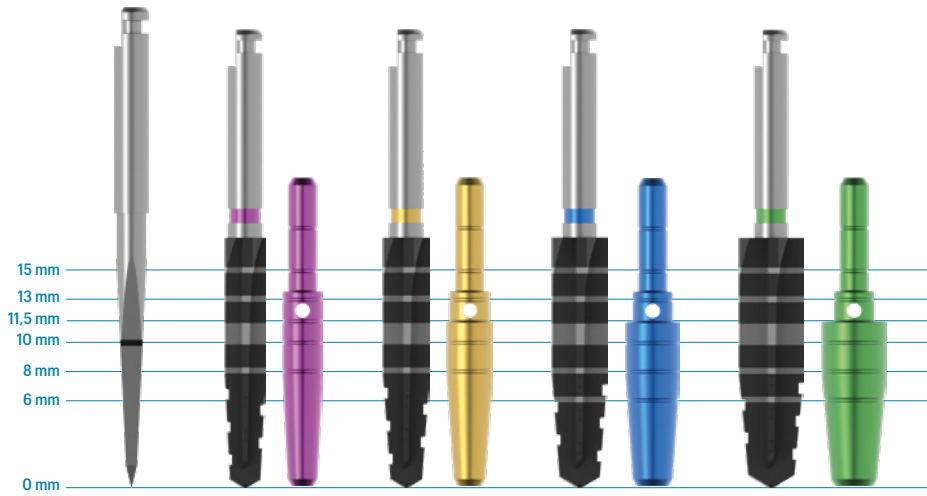

More specifically, the colours were inserted according to the coding defined by the company based on the diameters of the implants and summarised in the following table:

Colour	Diameters [mm]
Purple	3.2
Yellow	3.7
Blue	4.3
Green	5.0

In accordance with this coding, the implant diameter associated to each drill of the JDOneDrill kit is also indicated on the kit box.

The drilling sequence is the following:

IMPLANT DIAMETER	SOFT BONE	DENSE BONE
<b>Ø 3,2</b>	initial drill 3,2	initial drill 3,2 3,7 until the first laser mark
<b>Ø 3,7</b>	initial drill 3,2 3,7 (optional)	initial drill 3,2 3,7 4,3 until the first laser mark
<b>Ø 4,3</b>	initial drill 3,2 3,7 4,3 (optional)	initial drill 3,2 3,7 4,3 5,0 until the first laser mark
<b>Ø 5,0</b>	initial drill 3,2 3,7 4,3 5,0 (optional)	initial drill 3,2 3,7 4,3 5,0

## PREPARATION OF THE IMPLANT SITE IN CASE OF ATROPHIC MAXILLA

In cases of atrophic maxilla, implants may be inserted in the pterygomaxillary region or trans-sinus for the rehabilitation of the entire jaw.

### PTERYGOMAXILLARY SURGICAL PROTOCOL

The placement in the pterygoid region can be made following non-guided or computer guided surgical protocol. JDPterygo implants are particularly recommended for the insertion in the pterygomaxillary region.

#### Protocols for JDPterygo Ø 4.0 mm implants

##### **Non-Guided Protocol**

- Step 1: Start the osteotomy using JDPterygo drill Ø 2.0 mm at the same implant length to be inserted.
- Step 2: Continue with the preparation of the implant site using JDPterygo drill Ø 2.4 at the same implant length to be inserted.
- Step 3: Complete the osteotomy with JDPterygo drill Ø 3.2 mm at the entrance for 6 mm.

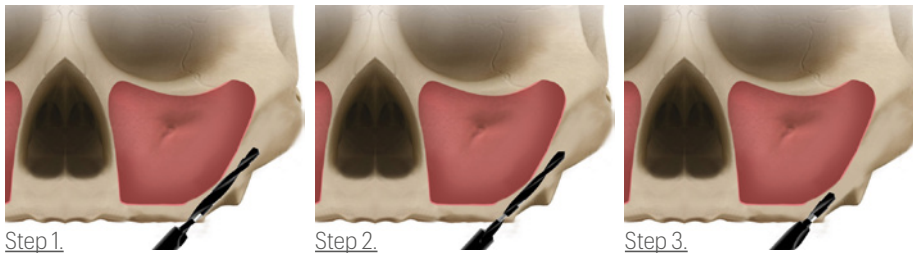

##### **Computer guided protocol**

- Step 1. Start the osteotomy using the first Guided Drill JDGD24-060 Ø 2.4 x L 6mm
- Step 2. Continue using Guided Drill Ø 2.4 at the same implant length to be inserted (Choose among Guided drills L 13 - 15 - 18 - 20 mm)
- Step 3. Continue with the Guided Drill Ø 2.8mm for 8mm
- Step 4. Complete the osteotomy with Guided Drill Ø 3.2mm for 6mm.





### Protocols for JDPterygo Ø 3.3 mm implants

#### **Non-Guided Protocol**

- Step 1: Start the osteotomy using JDPterygo drill Ø 2.0 mm at the same implant length to be inserted.
- Step 2: complete the osteotomy with JDPterygo drill Ø 2.8 mm at the entrance for 6 mm.

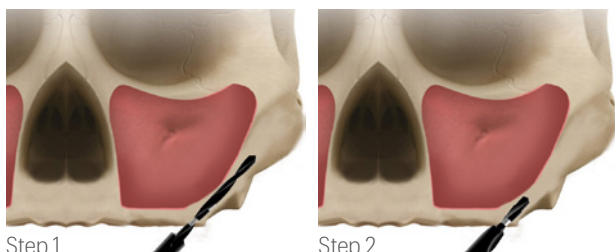

Step 1.

Step 2.

#### **Computer guided protocol**

- Step 1. Start the osteotomy using the Guided Drill Ø 2.0mm at the same implant length to be inserted.
- Step 2. Complete the osteotomy with Guided Drill Ø 2.8mm for 6mm.

## TRANS-SINUS SURGICAL PROTOCOL

JDNasal implants are particularly recommended for the trans sinus insertion. The trans-sinus placement can be made following non-guided or computer guided surgical protocol.

### Non-Guided Protocol 1

- Step 1. Open a window in the lateral sinus wall and gently reflect the Schneiderian membrane without perforating it. Initiate the preparation of the implant site with standard twist drill Ø 2.0mm in order to reach and perforate the floor of the maxillary sinus. Keep the drill with a right inclination towards the canine pillar.
- Step 2. Continue with standard twist drill Ø 2.4mm till to reach and perforate the floor of the maxillary sinus.
- Step 3. Continue with standard twist drill Ø 2.8mm till to reach and perforate the floor of the maxillary sinus.
- Step 4. Continue with standard twist drill Ø 3.2mm till to reach and perforate the floor of the maxillary sinus.
- Step 5. Insert the Initial drill JDNasal into the canal created into the bone before. Drill through the alveolar process, into and across the sinus, engaging the nasal bone in correspondence with the canine pillar.
- Step 6. Use the 26mm depth probe to verify the depth of the site, in order to support the clinician in the choice of the implant with the appropriate length.
- Step 7. Use the longer Ø 2.4mm JDNasal drill to drill like the previous one through the alveolar process, into and across the sinus, engaging the nasal bone until the final depth in correspondence with the canine pillar.
- Step 8A. Complete the osteotomy with standard twist drill Ø 3.6mm in the alveolar process.
- Step 8B. In case of implants of lengths of 28-30mm, instead to follow points 5-6-7, use JDNasal TranZ Drill through the alveolar process, within and across the maxillary sinus, engaging the nasal bone at the canine pillar.
- Step 9A. Place the implant and reach the final position without adding bone graft.
- Step 9B. Optional: place the implant, reach the final position and insert bone graft into the sinus. The implant shall be inserted with an insertion torque between 25 Ncm and 80 Ncm.

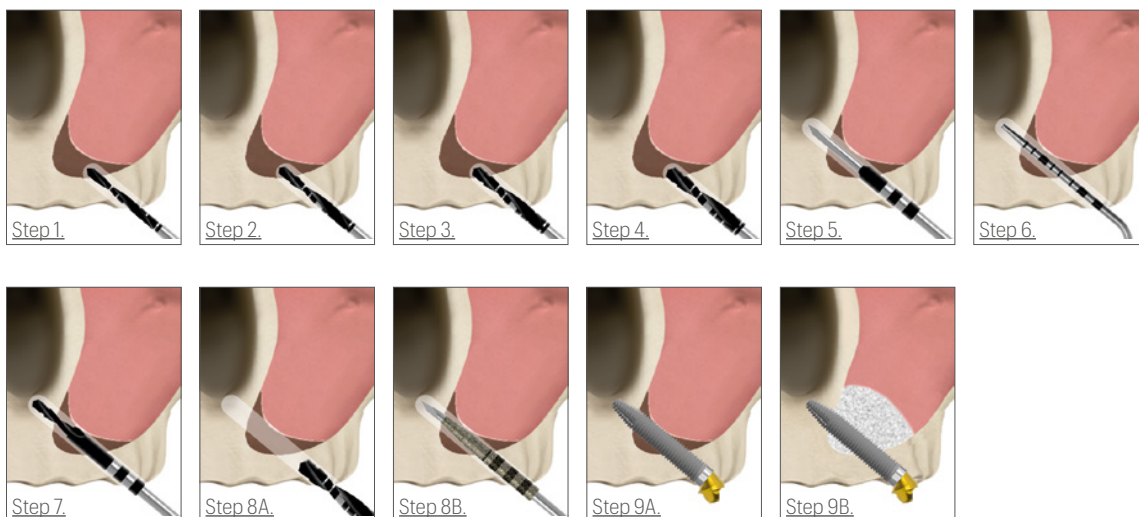

**Non-Guided Protocol 2**

- Step 1. Initiate the site preparation with the longer Ø 2.0mm JDNasal drill through the crestal bone and reach the cortical bone of the nose.
- Step 2. Use the 26mm depth probe to verify the depth of the site, in order to support the clinician in the choice of the implant with the appropriate length.
- Step 3. Drill to final depth with the longer Ø 2.4mm JDNasal drill.
- Step 4. Continue the osteotomy with standard twist drill Ø 2.8mm at the entrance for 6mm.
- Step 5. Continue the osteotomy with standard twist drill Ø 3.2mm at the entrance for 6mm.
- Step 6. Complete the osteotomy with standard twist drill Ø 3.6mm at the entrance for 6mm.
- Step 7. Place the implant till to reach the final position. The implant shall be inserted with an insertion torque between 25 Ncm and 80 Ncm.

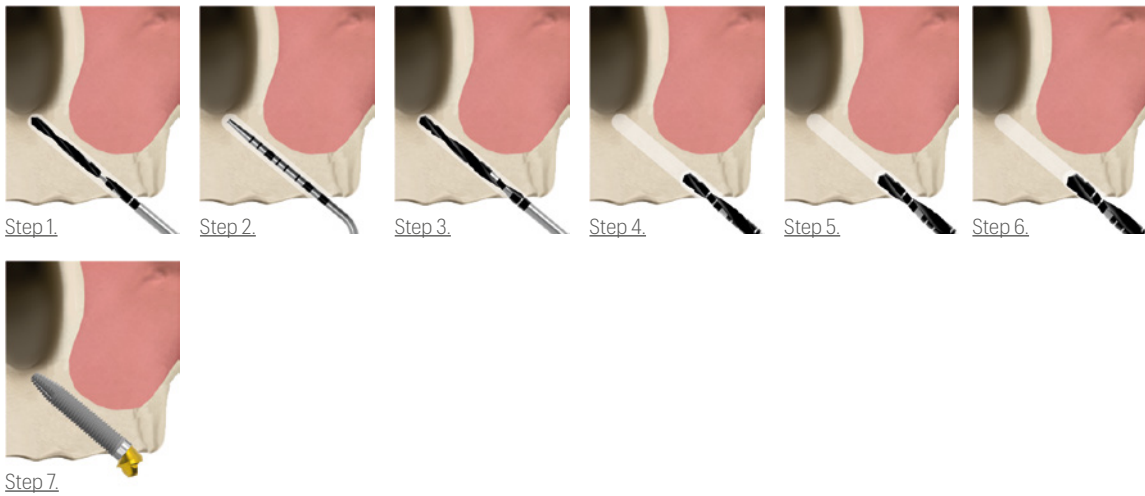

**Computer guided protocol**

IMPLANT DIAMETER	IMPLANT LENGTH	
Ø 4,0	L20	2,0 L6 - L8 - L10 - L11,5 - L13 - L15 - L18 - L20 2,4 L6 - L8 - L10 - L11,5 - L13 - L15 - L18 - L20 2,8 L6 - L8 - L10 - L11,5 - L13 3,2 L6 - L8 - L10 3,6 L6
	L22	2,0 L6 - L8 - L10 - L11,5 - L13 - L15 - L18 - L20 - L22 2,4 L6 - L8 - L10 - L11,5 - L13 - L15 - L18 - L20 - L22 2,8 L6 - L8 - L10 - L11,5 - L13 3,2 L6 - L8 - L10 3,6 L6
	L24	2,0 L6 - L8 - L10 - L11,5 - L13 - L15 - L18 - L20 - L22 - L24 2,4 L6 - L8 - L10 - L11,5 - L13 - L15 - L18 - L20 - L22 - L24 2,8 L6 - L8 - L10 - L11,5 - L13 3,2 L6 - L8 - L10 3,6 L6
	L26	2,0 L6 - L8 - L10 - L11,5 - L13 - L15 - L18 - L20 - L22 - L24 - L26 2,4 L6 - L8 - L10 - L11,5 - L13 - L15 - L18 - L20 - L22 - L24 - L26 2,8 L6 - L8 - L10 - L11,5 - L13 3,2 L6 - L8 - L10 3,6 L6

Note: all measurements in mm

## IMPLANT PLACEMENT

### Unpacking of the implant

The fixtures of JDentalCare dental implants are subjected to sterilization by gamma irradiation and are single-use devices. The fixtures are packaged in polystyrene vial, placed into a rigid thermoformed blister sealed with a Tyvek paper. An adhesive label is affixed to the blister of all JDentalCare implants and it reports the main information related to the device.

The intact sterile packaging protects the sterilized implant from outside influences and, if stored correctly, ensures the sterility of the device up to the expiration date. Before the use, check the integrity of the sterile barrier, check that the seal and the welds are intact, that the Tyvek paper is not damaged and/or cut and that there are not detachment points from the blister. On the blister of implants there is a red sticker, which is a gamma sterilization indicator. It confirms that the device has been subjected to sterilization by gamma radiation.

**Warning:** Do not use sterile devices after the expiration date.

**Warning:** Do not use fixtures if the gamma sterilization indicator is colored differently from red. Previously used or non-sterile implants must not be used under any circumstances.

**Warning:** The fixtures must not be cleaned, disinfected and/or re-sterilized by the users prior to use, since otherwise the main material and design features may be compromised, leading to device failure.

**Warning:** The device can be used only if the package is intact, closed and undamaged. Don't use the devices (both implants and prosthetic components) if the package has been damaged or previously opened. It is recommended to have a replacement implant at hand.

Any behavior different from the above may lead to infections, implant loss and to the failure of the treatment. JDentalCare disclaims any liability and shall have no responsibility for re-sterilized implants, regardless of who has carried out re-sterilization or by what method.



- Step 1: Remove the blister with the vial from the box



- **Step 2:** Open the blister: Open by pulling the peel tab located on the lower left corner of the blister. The sterile blister must be opened only at the moment it has to be used during the surgery. The vial must be handled with sterile gloves.



- **Step 3:** Remove the vial cap.



### Insertion of the implant

The implant shall be inserted slowly into the previously prepared site.

**Warning:** During insertion, do not exceed the maximum torque values indicated below:

- Ø 2,75mm implants: insertion torque between 25 Ncm and 60 Ncm
- All other implants: insertion torque between 25 Ncm and 80 Ncm.

- **Step 1:** Pick up the implant

The final placement of the dental implant, depending on the clinical situation, can be carried out using one of the following tools:

1. The JDTorque dynamometric key
2. The handpiece
3. The surgical driver

**Caution:** Pick up the implant taking care to extract it upright, avoiding any contact of it with other components of the vial (i.e blows and rubbing), because this may compromise the integrity of the implant.

**Implant placement with JD Torque dynamometric key:**

Attach the surgical adapter to the JD Torque dynamometric key. Connect the implant driver to the JD Torque dynamometric key with the mounted surgical adapter.



To connect the implant put light pressure on the driver.



Insert the implant in the previously made osteotomy. Move the implant into its final position turning it clockwise.

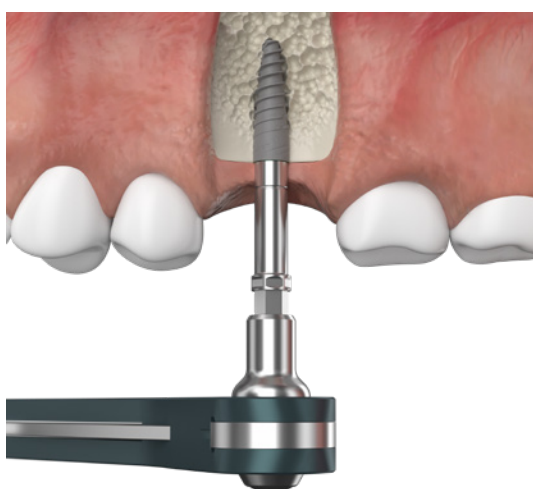

**FLAPLESS**



**WITH FLAP**

**In case of guided surgery:**

Attach the surgical adapter to the JDTorque dynamometric key. Connect the Driver Body for Guided Surgery (EVDG) to the JDTorque dynamometric key with the mounted surgical adapter from one side. On the other hand, connect the Driver Body for Guided Surgery (EVDG) to the specific Implant Mounter for the implant line to be used. Connect the mounter to the implant and then insert the implant in the previously made osteotomy. Move the implant into its final position turning it clockwise.

JDTorque dynamometric key with the mounted surgical adapter.

**Implant placement with Handpiece**

Connect the appropriate implant driver to the handpiece.

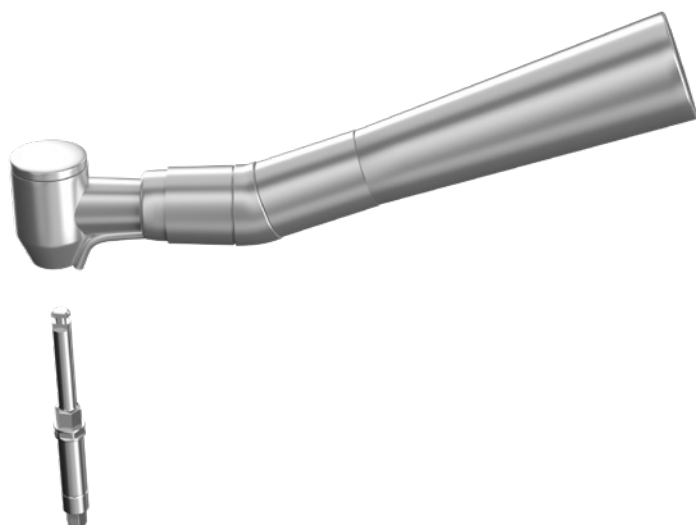

To connect the implant, apply light pressure on the driver.

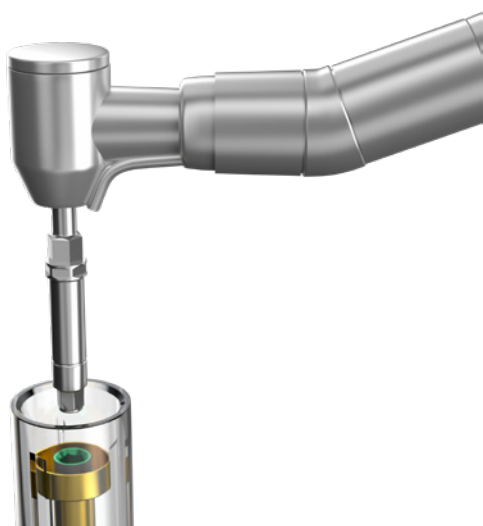

Slowly insert the implant in the previously made osteotomy (25 rpm for standard implants, 15 rpm for narrow diameter implants).

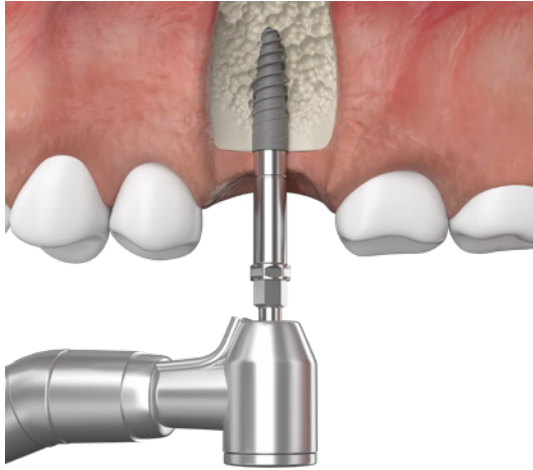

**FLAPLESS**

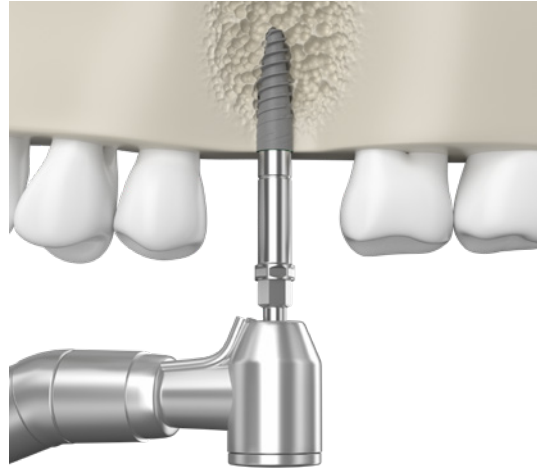

**WITH FLAP**

***In case of guided surgery:***

Connect the Driver Body for Guided Surgery (EVDG) to the handpiece from one side. On the other hand, connect the Driver Body for Guided Surgery (EVDG) to the specific Implant Mounter for the implant line to be used. Connect the mounter to the implant and then insert the implant in the previously made osteotomy. Move the implant into its final position turning it clockwise.

***Implant placement with the surgical driver***

It is also possible to use the surgical driver to position the implant. Connect the implant driver to the surgical driver.

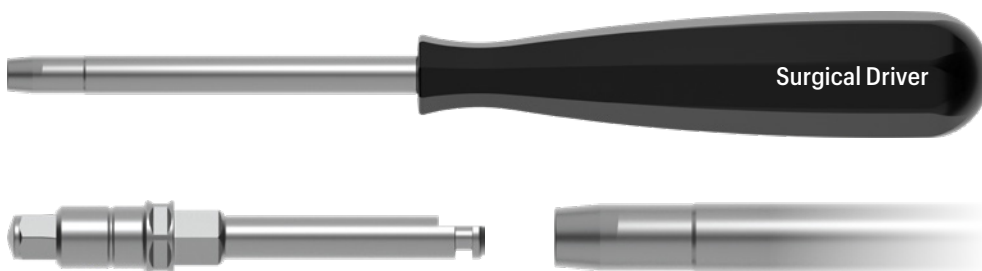



To connect the implant, apply light pressure on the drive.



Insert the implant in the osteotomy previously carried out.

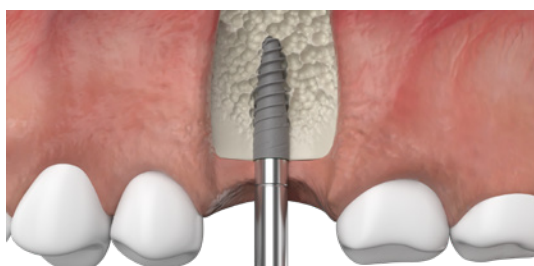

**FLAPLESS**

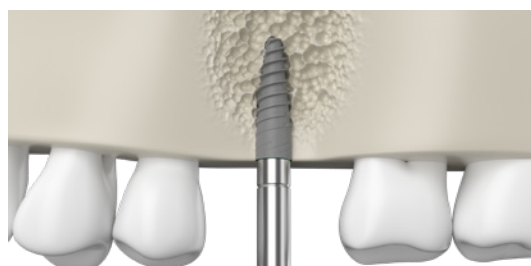

**WITH FLAP**

• Step 2: Final positioning

Connect the JD Torque dynamometric key with the JD Torque surgical adapter mounted on the driver of the implant and seat the implant to its final depth. To carry out immediate load protocols, the implant should be inserted with a final insertion torque of 25÷45 Ncm but without exceeding in any case 80 Ncm. You can withdraw the driver by extracting it with vertical movement.



For an optimal esthetic result, place the implant on the bone crest or up to 0.5 to 1 mm below.

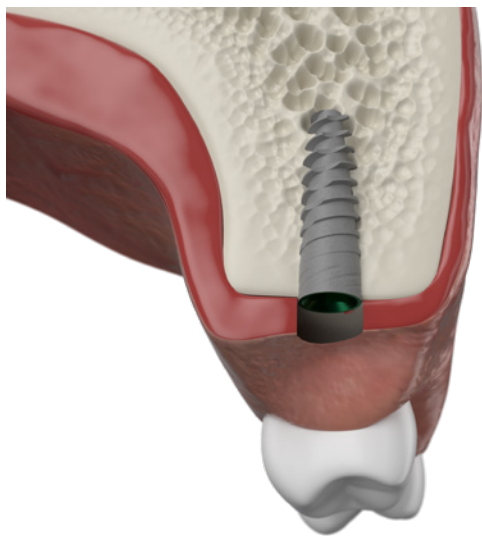

**Caution:** Avoid excessive force when inserting the implant with the dynamometric key given that inadequate pressure on the bone could cause necrosis and compromise integration with the bone. If you observe excessive torque (of approximately 80 Ncm) at any stage of the insertion, rotate the implant in the counter-clockwise direction two or three turns in order to take advantage of its self-tapping capacity and continue with the insertion. However, if you still encounter too much resistance, pull out the implant and carry out a more extensive osteotomy.

**Caution:** For JDIcon Ultra S dental implants never exceed insertion tightening torque of 60 Ncm for the implant and 20 Ncm for the abutment.

### Implant Orientation

At the time of the final placement of the implant, when the desired depth has been reached, it is necessary to align the reference points in the driver with the vestibular wall. The profile of the internal connections of JDentalCare dental implants makes it possible to place and to orient the implant using implant drivers.



The implant driver has a 3 mm mark to facilitate the vertical positioning of the implant platform in accordance to soft tissue thickness (applicable in flapless surgery).



**Cleaning The Surgical Site**

After the placement of the implant, the site shall be irrigated with sterile water or saline solution in order to remove any residual of bone and tissue debris and/or blood. This procedure is preparatory to the following insertion of the prosthetic components.

**Implant passport**

At the end of the surgical procedure stick labels with all implant's information (sizes and batch number) on the implant passport.



**Post-Operative Care**

Patient should be informed and on the need for regular oral hygiene. It is important that regular check-up is carried out in order to complete in the best way the planned implant-prosthetic treatment.

---

# ***PROSTHETIC PROCEDURE***

## FINALISATION OF THE IMPLANT SURGERY

After implantation, the implant is closed with the cover screw (provided together with each JDentalCare implant), the healing abutment or healing cap (in case of conical abutment) to protect the implant. Based on the case and his/her preferences, the clinician can choose between submerged or non-submerged healing and between immediate and delayed function. JDentalCare implants are suitable both for immediate, early and delayed loading.

### Immediate loading

Immediate loading, involves the placement of a restoration within 48 hours of implant placement. Immediate loading is indicated when there are good primary stability and an appropriate occlusal load, and is made in case of non-submerged healing. Immediate loading reduces treatment time, allows immediate restoration of function and esthetics with subsequent increasing of patient satisfaction. It is possible to fix a provisional prosthesis using the JDentalCare provisional components or definitive abutments.

### Early loading

Early loading protocol foresees that the implants are loaded between 1 week and 2 months after insertion. Early loading can be performed using both submerged or non-submerged healing.

### Delayed loading

In the delayed loading protocol, after the placement of dental implants, is required a 3-6 months load-free healing period for healing and osseointegration. Delayed loading can be performed using both submerged or non-submerged healing.

### Submerged healing

Cover screws are used in case of submerged healing.

#### How to use:

- **Step 1:** Remove the cover screw from the cap of the vial where it is provided with the implant.
- **Step 2:** Use the prosthetic screwdriver to thread the screw into the implant ensuring the proper thread engagement between the two components.
- **Step 3:** After placement of the Cover Screw, take a radiograph to check the position prior to close the soft tissue.
- **Step 4:** Replace the soft tissue flaps carefully over the cover screw and suture together.

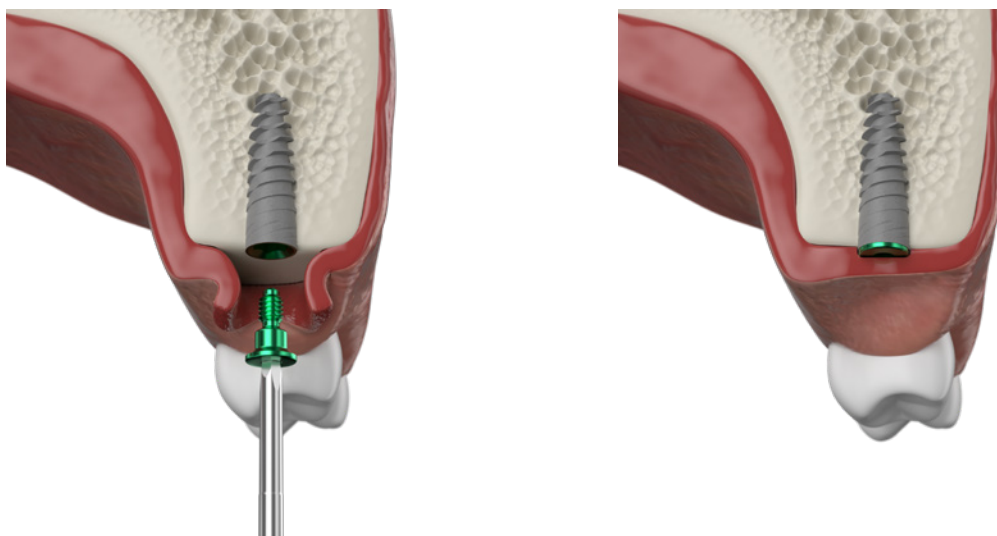

### Non-Submerged healing

by using Healing abutment Healing abutments are used in case of non-submerged healing. They promote soft and hard tissue healing around an implant. The design of JDentalCare healing abutment with integrated Platform Switching favors the soft tissue shaping, promoting a greater long term stability of these tissues, and a limited crestal bone resorption.

#### How to use

- Step 1: Clean the internal connection of the implant with sterile water or saline solution.
- Step 2: Select the healing abutment of appropriate size. Place the healing abutment into the implant and tighten the prosthetic screw using the prosthetic screwdriver.
- Step 3: Adapt the soft tissue and suture it around the healing abutment.
- Step 4: It is advisable to take a radiograph after the insertion of the healing abutment.

#### How to choose the appropriate healing abutment

- Step 1: Determine the size of implant platform.
- Step 2: Choose the emergency profile based on the clinical case considered and the crown that will be manufactured.
- Step 3: Select the diameter corresponding to that of the final abutment to be used.
- Step 4: Choose the length in order to have a slight protrusion of the device above the surrounding tissue.

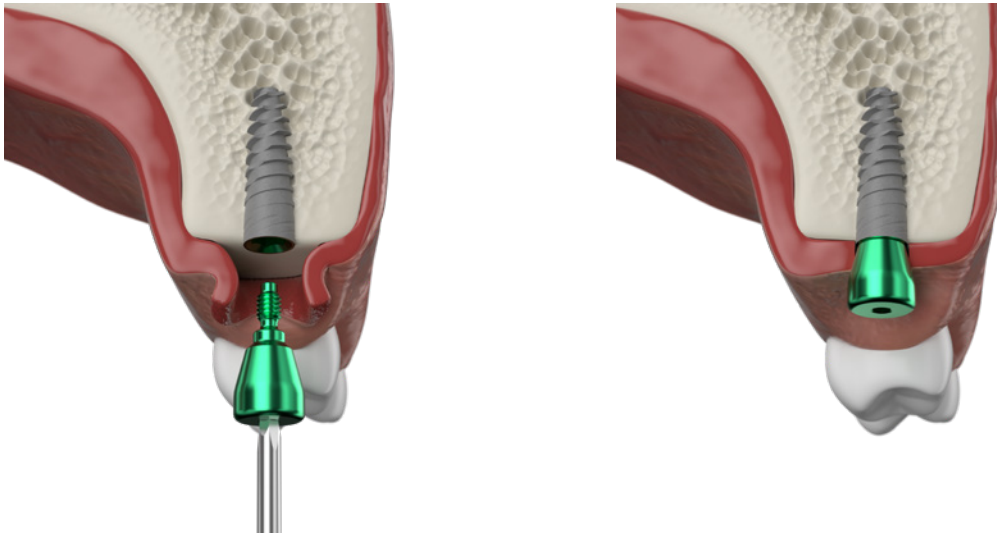

### Bone Mill

Bone mill is used to remove bone surrounding the implant platform in case of interference with complete seating of any component (healing abutment, impression coping, abutment). It is possible to remove this interference using Bone Mill manually or at low speed on the handle with the specific guide mounted on the implant. The speed must not exceed 100 rpm. Bone Mill serves especially when the implant is placed at subcrestal level.



BONE MILL Ø 5.0



BONE MILL Ø 6.0

### How to use

- Step 1: Remove the cover screw.
- Step 2: Insert the Bone Mill Guide in the implant and screw it by means of the Screwdriver.
- Step 3: Connect the Bone Mill to the contra-angle handpiece. Before starting the machine, put the Bone Mill on the Bone Mill Guide and start to run with low speed until the instrument is fully seated on the guide. A plentiful irrigation with sterile water or saline solution is recommended.
- Step 4: When the bone surrounding the implant platform has been sufficiently removed, it is possible to insert the abutment. Make sure that the implant platform is clean and free from bone debris.

## INSERTION OF PROSTHETIC COMPONENTS

The prosthetic components can be picked, depending on the clinical situation, using one of the following tools:

- The JDTorque dynamometric key: connect the JDTorque dynamometric key to the prosthetic adapter and using the screw driver proceed to screw in the prosthetic components.
- The handpiece
- The manual screw driver: Connect the JDTorque prosthetic adapter to the machine screw driver and manually screw in the prosthetic component.



## CONICAL ABUTMENTS ALIGNING INSTRUMENTS

Conical abutment alignment instruments are devices intended for picking up and inserting the endosseous implant and checking the inclination of the implant to choose the correct conical abutment to use.

They are equipped with a body and 5 or 3 angle indicators, all identified with laser inclination markings, used to verify the inclination of the implant to choose the correct conical abutment to be inserted. They also have a hexagonal attachment for picking up the implants.

### **How to use**

1. Insert the conical abutment aligning instrument into the implant
2. Measure the angulation of the implant, reading the corresponding number on the indicator, and choose the correct abutment with the right angulation (17°, 30°, 35°).

## IMPRESSION TECHNIQUE

Following the recommended healing phase after implant placement, it is necessary to take the impression of the patient's mouth for final restoration. Taking impressions is necessary to ensure that the prosthesis fits into patient's mouth. Impressions are used when creating crowns, dental implants and bridges. The technique that will be selected depends on several factors, such as the position and the type of restoration that will be chosen and the experience of the practitioner. The bite registration and the tooth color assessment should also be taken at this point. The impression can be complete, when it captures all teeth and surrounding tissues of the dental arch, or partial, when it captures only a part of the arch.

Impression techniques used in the implant treatment:

- Closed tray
- Open tray
- Abutment level impression



- Conventional impression
- Intraoral scanning for 3D dental impressions.

In general, for single unit restorations the closed tray and open tray techniques can be used interchangeably.

### Closed Tray impression technique

This technique is recommended for single unit restorations or multiple unit restorations where implants are placed sufficiently parallel to each other.

The procedure to take a closed tray impression is the following:

- Step 1: Unscrew the healing cap using the prosthetic screwdriver.
- Step 2: Place the impression coping closed tray into the implant and tighten the Impression Coping Closed Tray Screw using the prosthetic screwdriver.
- Step 3: Apply impression material around the impression coping to surround it completely.
- Step 4: Fill the tray with impression material and take the impression directly in the mouth.
- Step 5: Once the material is cured, carefully remove the tray.
- Step 6: Unscrew and remove the impression coping from the patient's mouth.
- Step 7: Mount the implant replica on the impression coping using the Prosthetic Screwdriver.
- Step 8: Insert the system impression replica-impresion coping into the impression previously taken.
- Step 9: Use the impression to create a model.

In case there is the conical abutment inserted into the implant, the procedure to take a closed tray impression is the following:

- Step 1: Place the impression coping closed tray on the conical abutment.
- Step 2: Apply impression material around the impression coping to surround it completely.
- Step 3: Fill the tray with impression material and take the impression directly in the mouth.
- Step 4: Once the material is cured, carefully remove the tray.
- Step 5: Take out the impression copings, mount the conical abutment replica into the impression previously taken.
- Step 6: Use the impression to create a model.

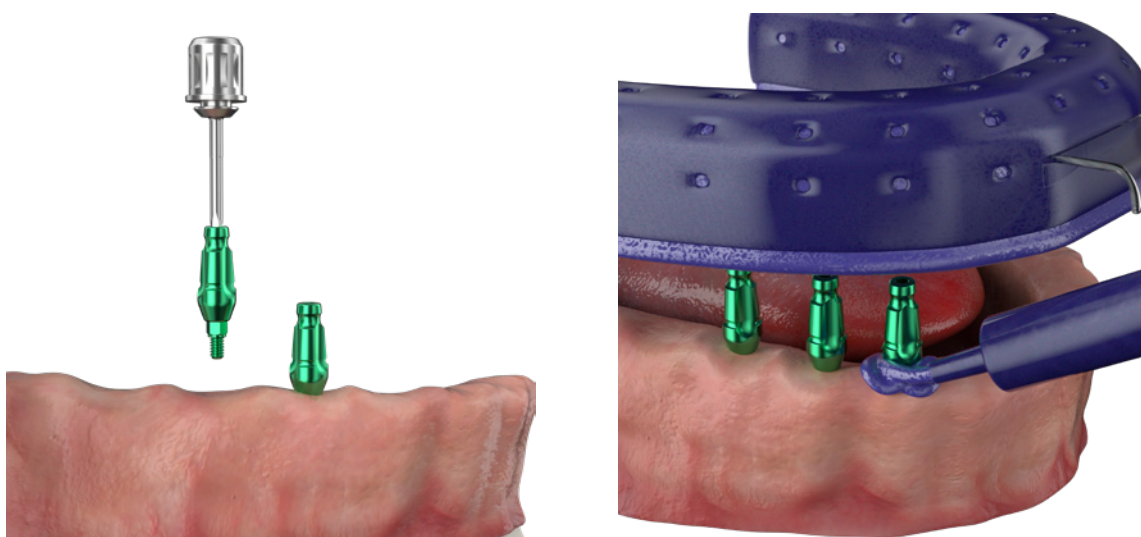

### Open tray impression techniques

This technique is used for single unit restorations or multiple unit restorations where the implants are misaligned and the absence of parallelism would hinder the removal of a closed tray impression resulting in distortion of the impression.

- Step 1: Unscrew the healing cap using the prosthetic screwdriver.
- Step 2: Place the impression coping open tray into the implant and tighten the Impression Coping open Tray Screw using the prosthetic screwdriver.
- Step 3: Apply impression material around the impression coping to surround it completely.
- Step 4: Fill the tray with impression material and take the impression directly in the mouth. Ensure that you see all the tops of the impression copings emerging from the tray.
- Step 5: Remove Impression Coping Open Tray Screw using the prosthetic screwdriver.
- Step 6: Once the material is cured, carefully remove the tray together with the impression coping open tray which remains inside the impression material.
- Step 7: Mount the implant replica on the impression coping using the Prosthetic Screwdriver.
- Step 8: Use the impression to create a model.

In case there is the conical abutment inserted into the implant, the procedure to take a open tray impression is the following:

- Step 1: Place the impression coping open tray on the conical abutment and screw it using the prosthetic screwdriver.
- Step 2: Apply impression material around the impression coping to surround it completely.
- Step 3: Fill the tray with impression material and take the impression directly in the mouth. Ensure that you see all the tops of the impression copings emerging from the tray.
- Step 4: Once the material is cured, unscrew the impression coping and carefully remove the tray together with the impression coping open tray which remains inside the impression material.
- Step 5: Mount the conical abutment replica on the impression coping using the Prosthetic Screwdriver.
- Step 6: Use the impression to create a model.

In case there is the octa abutment inserted into the implant, the procedure to take a closed tray impression is the following:

- Step 1: Place the impression coping open tray on the octa abutment and screw it using the prosthetic screwdriver.
- Step 2: Apply impression material around the impression coping to surround it completely.
- Step 3: Fill the tray with impression material and take the impression directly in the mouth. Ensure that you see all the tops of the impression copings emerging from the tray.
- Step 4: Once the material is cured, unscrew the impression coping and carefully remove the tray together with the impression coping open tray which remains inside the impression material.
- Step 5: Mount the octa abutment replica on the impression coping using the Prosthetic Screwdriver.
- Step 6: Use the impression to create a model.

In case there is the conometric abutment inserted into the implant, the procedure to take a closed tray impression is the following:

- Step 1: Place the impression coping on the octa abutment and screw it using the prosthetic screwdriver.
- Step 2: Apply impression material around the impression coping to surround it completely.
- Step 3: Fill the tray with impression material and take the impression directly in the mouth. Ensure that you see all the tops of the impression copings emerging from the tray.
- Step 4: Once the material is cured, unscrew the impression coping and carefully remove the tray together with

the impression coping open tray which remains inside the impression material.

- Step 5: Mount the octa abutment replica on the impression coping using the Prosthetic Screwdriver.
- Step 6: Use the impression to create a model.

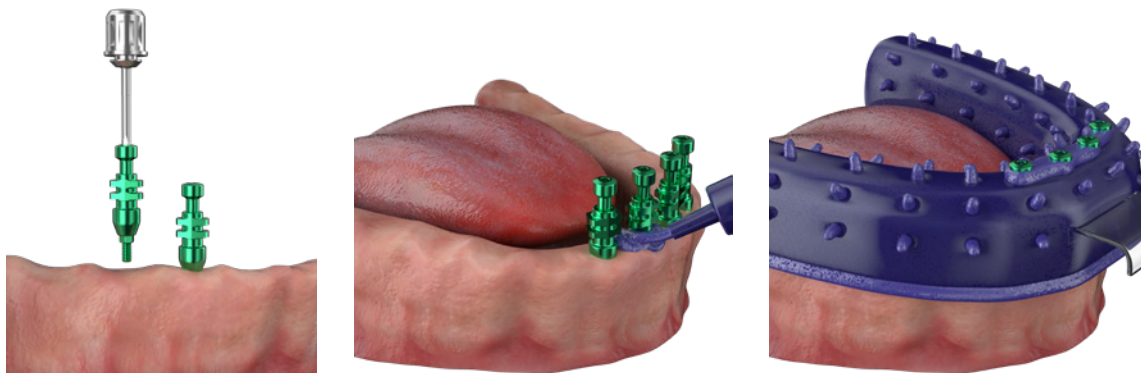

### Abutment level impression

- Step 1: Unscrew the healing cap using the prosthetic screwdriver.
- Step 2: Place the Rapid abutment into the implant and tighten the prosthetic. Screw using the prosthetic screwdriver.
- Step 3: Place the Coping for Rapid abutment on the Rapid abutment.
- Step 4: Apply impression material around the to surround it completely.
- Step 5: Fill the tray with impression material and take the impression directly in the mouth.
- Step 6: Once the material is cured, carefully remove the tray together with the coping which remains inside the impression material.
- Step 7: Mount the abutment replica on the Coping.
- Step 8: Use the impression to create a model.



### Conventional impression

This technique is used when the dentist selects and modifies a definitive abutment to cement a single or multiple unit restorations (crown or bridge).

- Step 1: The abutment is placed to the implant, modified using conventional preparation methods directly in the mouth, using high speed handpiece with abundant irrigation.
- Step 2: Apply impression material around the abutment previously prepared to surround it completely.
- Step 3: Fill the tray with impression material and take the impression directly in the mouth.
- Step 4: Once the material is cured, carefully remove the tray.
- Step 5: Use the impression to create a model

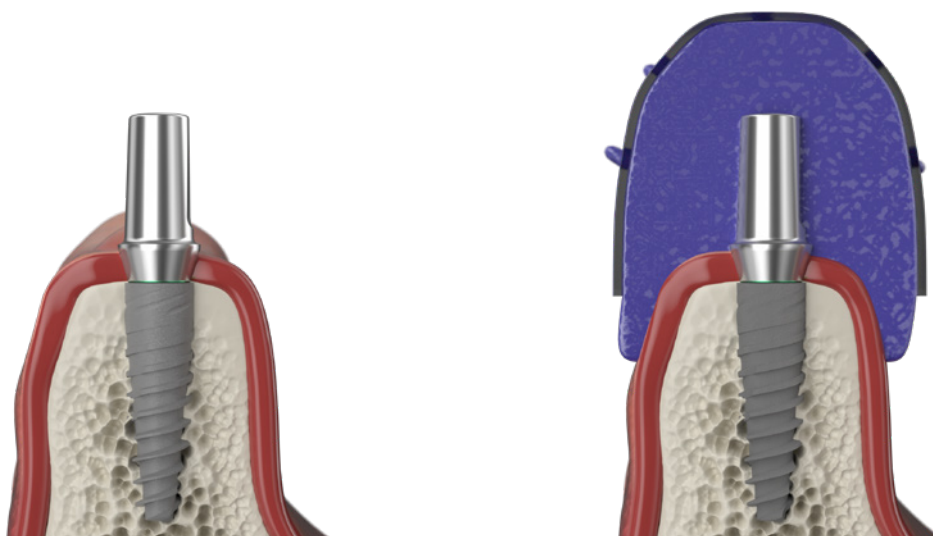

### Intraoral scanning

JDentalCare provides open implant libraries for all JDentalCare Implant lines to guarantee maximum precision and flexibility to the prosthesis construction. Using apposite intraoral scanners (IOS) and all JDentalCare solutions for intraoral scanning, it's possible to take an accurate 3D intraoral impression of the oral cavity directly in patient's mouth.

- Step 1: Unscrew the healing cap using the prosthetic screwdriver.
- Step 2: Place the JDScanbody into the implant and tighten the prosthetic screw using the prosthetic screwdriver
- Step 3: Take the 3D intraoral impression using the IOS.
- Step 4: Design the prosthesis in the CAD software.



The conical abutment can be used for imaging of the implant location, when linked to a Scanbody for conical abutment.

- Step 1: Unscrew the healing cap using the prosthetic screwdriver.
- Step 2: Place the ScanBody for conical abutment on the platform of the conical abutment, using the prosthetic screwdriver.
- Step 3: Take the 3D intraoral impression using the IOS.
- Step 4: Design the prosthesis in the CAD software.

The On Top ScanBody simplifies the scanning procedure because it allows to take an impression only by scanning the top of the ScanBody.

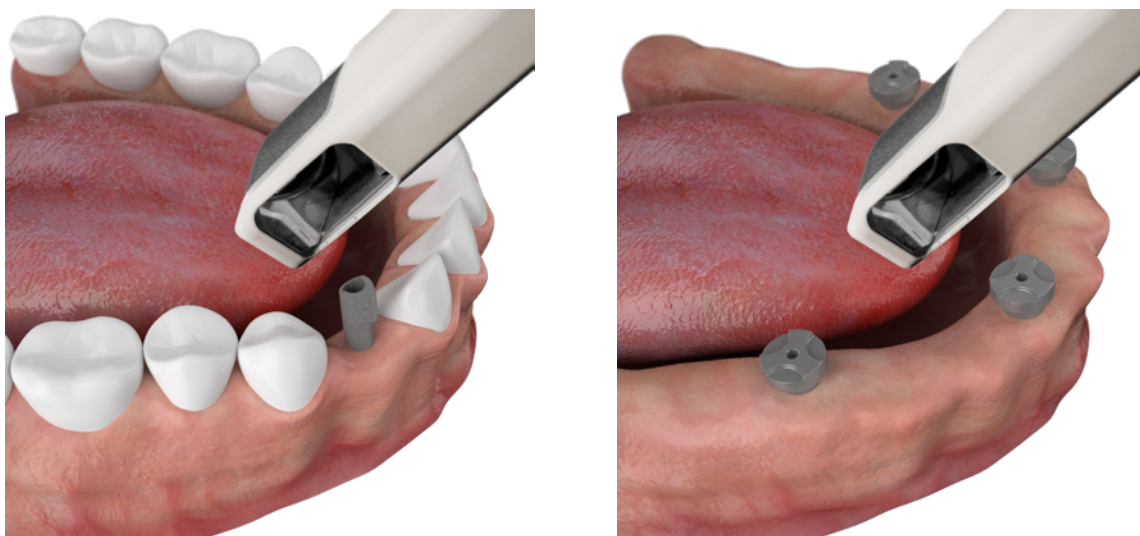

All JDentalCare Implant libraries for Exocad, 3Shape and DentalWings are available at [www.jdentalcare.com](http://www.jdentalcare.com). Ask to our offices or contact your local JDentalCare distributor for more info.

## TEMPORARY SOLUTIONS FOR DENTAL LABORATORIES

### Temporary Abutments

Temporary abutments are used to manufacture a cement-retained or screw-retained provisional restorations, in immediate function cases or to allow for the remodeling of soft tissue after that a healing abutment has been used. Temporary abutments engaging are indicated for screw-retained or cement-retained single-unit restorations. Temporary abutments non-engaging are indicated for screw-retained multiple-unit restorations.

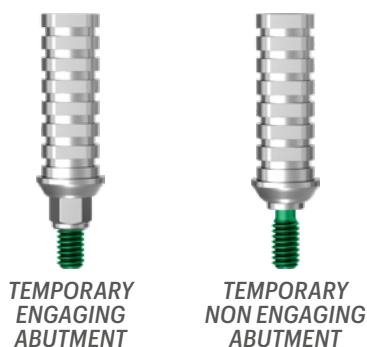

### How to use temporary abutments engaging for cement-retained implant crowns

- Step 1: Make a master model with one or more implant replicas inserted inside.
- Step 2: Place and insert into the implant replica, the temporary abutment engaging.
- Step 3: Modify the temporary abutment engaging in function of the current situation in the mouth of the patient, verifying the necessary occlusal space for the covering materials (do not reduce the abutment to less than 4mm in height).
- Step 4: Realize the crown or bridge to be cemented using conventional methods.
- Step 5: Place the temporary abutment engaging on the implant and tighten the prosthetic screw using the prosthetic screwdriver with a torque ranging from 15 to 30 Ncm. Cover the screw access channel of the abutment with cotton and sealing compound (i.e, gutta-to percha). This enables the dentist to remove later the abutment if a modification of the restoration is necessary.
- Step 6: Try the crown in the patient's mouth and, if necessary, modify it.
- Step 7: Fill the shell crown with temporary cement, and place it on the temporary abutment.
- Step 8: Remove any excess cement.



**How to use temporary abutments engaging for screw-retained implant crowns:**

- Step 1: Make a master model with one or more implant replicas inserted inside.
- Step 2: Place and insert into the implant replica, the temporary abutment engaging.
- Step 3: Modify the temporary abutment engaging in function of the current situation in the mouth of the patient, verifying the necessary occlusal space for the covering materials (do not reduce the abutment to less than 4mm in height).
- Step 4: Temporarily seal the screw access channel of the abutment (e.g. with cotton).
- Step 5: Realize the crown using conventional methods, making an access hole to allow the insertion of the prosthetic screwdriver.
- Step 6: Fill the shell crown with temporary cement, and place it on the temporary abutment.
- Step 7: Remove any excess cement.
- Step 8: Place the abutment+crown system on the implant and tighten the prosthetic screw using the prosthetic screwdriver with a torque ranging from 15 to 30 Ncm.
- Step 9: Where necessary, cover the access hole in the crown/bridge, with cotton and sealing compound (i.e. gutta-percha, composite). This enables the dentist to remove later the abutment if a modification of the restoration is necessary.

**How to use temporary abutments non-engaging for screw-retained bridges:**

- Step 1: Make a master model with the implant replicas inserted inside.
- Step 2: Place and insert into the implant replicas, the temporary abutments non-engaging.
- Step 3: Modify the temporary abutments non-engaging in function of the current situation in the mouth of the patient, verifying the necessary occlusal space for the covering materials (do not reduce the abutment to less than 4mm in height).
- Step 4: Temporarily seal the screw access channel of the abutment (e.g. with cotton).
- Step 5: Realize the bridge using conventional methods, making an access hole to allow the insertion of the prosthetic screwdriver.
- Step 6: Fill the bridge with temporary cement, and place it on the temporary abutments.
- Step 7: Remove any excess cement.
- Step 8: Place the abutment+ bridge system on the implant and tighten the prosthetic screw using the prosthetic screwdriver with a torque ranging from 15 to 30 Ncm.

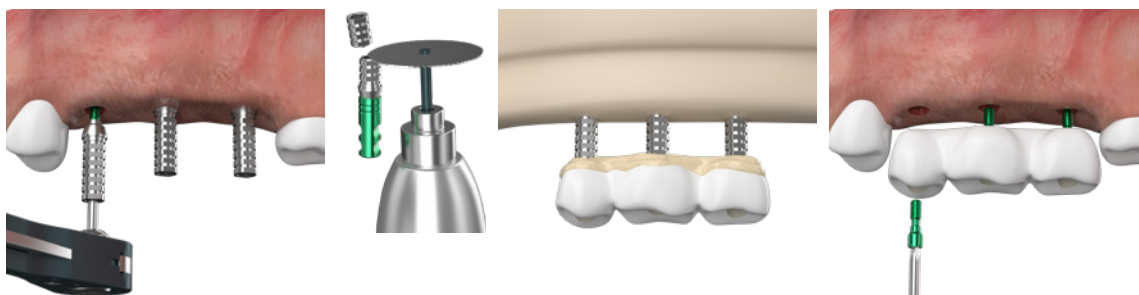

### Immediate Temporary Abutments

Temporary abutments are used to manufacture a cement-retained provisional restorations, in immediate function cases.



**IMMEDIATE TEMPORARY ABUTMENT  
AND IMMEDIATE TEMPORARY  
ABUTMENT HEALING CUP**

#### How to use:

- Step 1: Make a master model with one or more implant replicas inserted inside.
- Step 2: Place the abutment into the implant and tighten the prosthetic screw using the prosthetic screwdriver for conical abutment with a torque ranging from 15 to 30 Ncm.
- Step 3: Check the direction and the length of the abutment with respect to the adjacent teeth and/or implants. Modify the abutment in function of the current situation in the mouth of the patient, verifying the necessary occlusal space for the covering materials.
- Step 4: Place the Immediate temporary Abutment healing cap on the Immediate Temporary Abutment and relieve it if necessary, during the period of realization of the temporary prosthesis.
- Step 5: Realize the crown to be cemented using conventional methods.
- Step 6: Try the crown or bridge in the patient's mouth and, if necessary, modify it.
- Step 7: Fill the shell crown or bridge with provisional cement, and place it on the abutment.
- Step 8: Remove any excess cement.

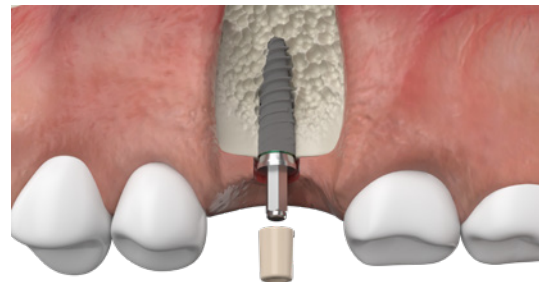
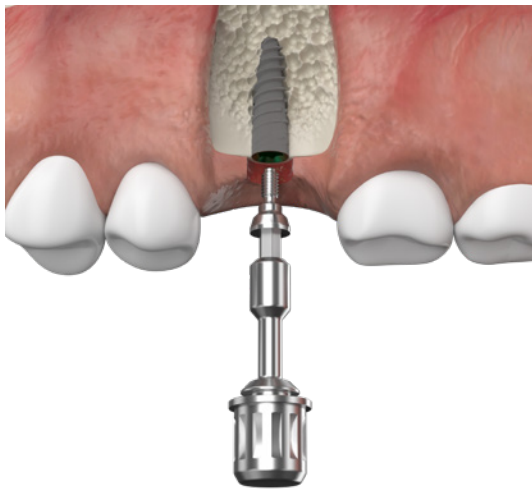



## FINAL ABUTMENT SELECTION

The selection of the final abutment is decisive for the result of the prosthesis to comply with the functional and esthetic requirements of the dentist and patient. The dentist can choose the abutment and subsequently send to the laboratory an impression taken at the abutment level, or can take a direct implant level impression and later communicate to the dental technician which abutment to use. For a proper selection of the final abutment, it is necessary to consider some aspects, such as: - the type of restoration to be used: screw-retained or cement retained restorations. - the gingival height: to determine the correct height of the soft tissue, measure with a probe the depth of the latter around the implant. The selection of the abutment transgingival height will depend on the hygienic and the esthetic considerations of the dentist. - the interdental space, - the emergence profile, - the inclination of the implant: depending on the inclination of the system, it is chosen whether to use a straight or angled, or if it is necessary a customized abutment.

### Type of provisional and definitive restorations

JDentalCare implants are suitable for different treatment options:

- Implant-supported crown in case of single missing tooth
- Implant supported fixed bridge in case of several missing teeth
- Implant supported denture in case of all missing teeth
- Overdenture to be seated on ball attachments in case of all missing teeth.

There are three types of prostheses:

#### **Cement-retained prosthesis**

Cemented restorations are placed using the same conventional protocols that are used in the techniques of cemented crowns and bridges over natural teeth. The abutment is tightened into the implant and the prosthesis is cemented on it.

The cement-retained restorations have the following advantages:

- are preferred for esthetic applications, due to the absence of the screw access hole in the crown,
- are suitable for situations with angled implants,
- passive fit is easier to accomplish due to the cement layer between the abutment and reconstruction,
- ideal occlusal contact can be obtained and remains stable over a long period of time.

The main disadvantage is the difficulty of removing excess cement, that was identified as a possible risk indicator for peri-implant diseases.

#### **Screw-retained prosthesis**

A screwed-in prosthesis is affixed with screws through the occlusal part of the prosthesis. The screw goes through a hole made into the crown and goes into the abutment or into the implant. The prosthesis may be unscrewed at any time by the dentist. This hole is then covered with composite, to avoid seeing the screw in particular in aesthetic areas.

The screw-retained restorations have the following advantages:

- No need to use cement, with less risk of inflammation and infection,
- they simplify periodic cleaning of implants; simply remove the screw to remove the prosthesis and have access to the implant.

The main disadvantage is that the hole in the crown may affect the aesthetics.

**Conometric prosthesis**

The conometric prosthesis is a fixed prosthesis that combines the advantages of screw retained and cement retained prostheses. This prosthesis doesn't require the application of cement, because the connection is obtained with friction retention.

The conometric prostheses have the following advantages:

- are preferred for esthetic applications, due to the absence of hole in the crown and residual sub-mucosal cement
- guarantees fixed retention, allowing the easy removal by the dentist when necessary (All the modifications and repairs can be executed easily outside the mouth).

**Prosthesis types**

**Cement-retained single-unit or multiple-unit restorations**

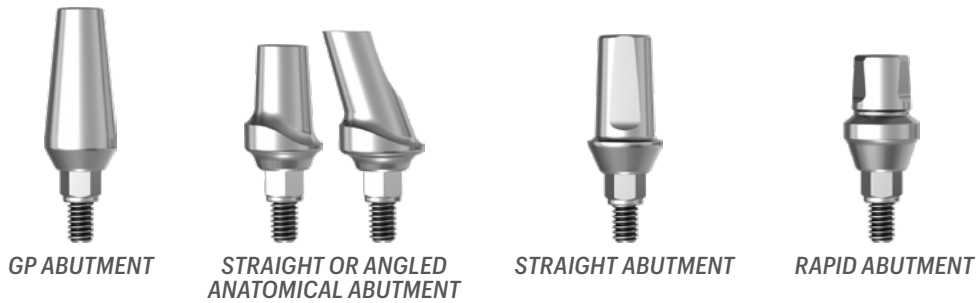
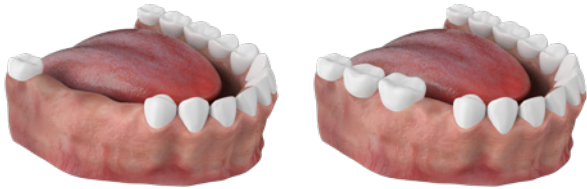

**Screw-retained restorations**



**Conometric Prosthesis**



**STRAIGHT AND ANGLED  
CONOMETRIC ABUTMENT**

**Overdentures**



**CONICAL  
ABUTMENT**



**ANGLED CONICAL  
ABUTMENT**



**BALL  
ABUTMENT**



**EMI  
ABUTMENT**

*Caution: Small diameter implants and angled abutment are not recommended for the insertion in the posterior regions of the mandible and the maxilla.*

## DEFINITIVE SOLUTIONS FOR CEMENT-RETAINED RESTORATIONS

### Straight abutments, Gp Abutments, Rapid Abutments and Anatomic Abutments

Straight abutments, Gp Abutments, Rapid Abutments and Anatomic Abutments are used for cement-retained definitive single-unit or multiple-unit restorations.

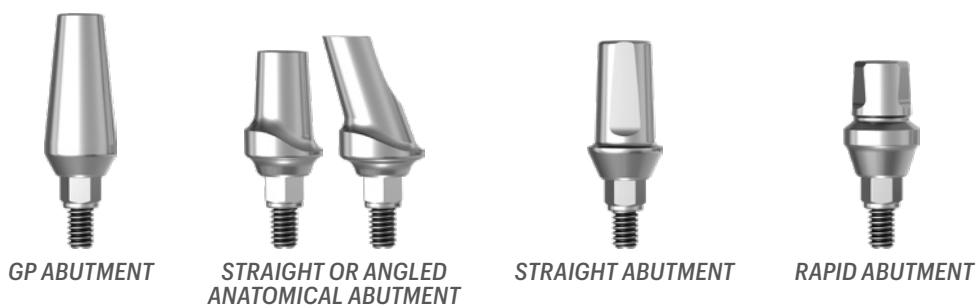

- Step 1: Make a master model with one or more implant replicas inserted inside.
- Step 2: Place the abutment into the implant replicas and tighten the prosthetic screw using the prosthetic screwdriver.
- Step 3: Check the direction and the length of the abutment with respect to the adjacent teeth and/or implants. Modify the abutment inserted in the model, in function of the current situation in the mouth of the patient, verifying the necessary occlusal space for the covering materials (do not reduce the abutment to less than 4 mm in height).
- Step 4: Realize the crown or bridge to be cemented using conventional methods.
- Step 5: Place the abutment on the implant and tighten the prosthetic screw using the prosthetic screwdriver with a torque ranging from 15 to 30 Ncm. Cover the screw access channel of the abutment with cotton and sealing compound (i.e, gutta-percha). This enables the dentist to remove later the abutment if a modification of the restoration is necessary.
- Step 6: Try the crown or bridge in the patient's mouth and, if necessary, modify it.
- Step 7: Fill the shell crown or bridge with definitive cement, and place it on the abutment.
- Step 8: Remove any excess cement.

The above-mentioned abutments can be also used as provisional abutments, following the same procedure described above, with temporary prosthesis.

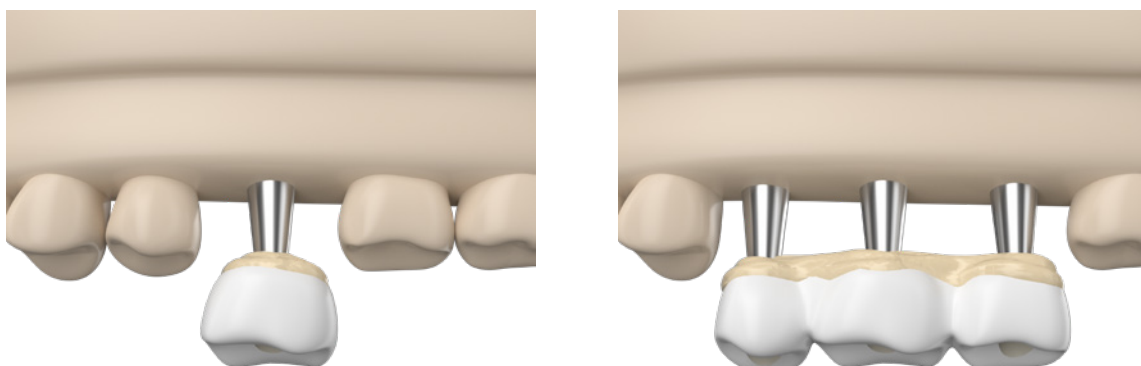

## DEFINITIVE SOLUTIONS FOR SCREW-RETAINED RESTORATIONS

### Conical Abutment

The conical abutments are intended only for screw-retained definitive multi-units restorations (full arch or, without the need to correct the inclination).

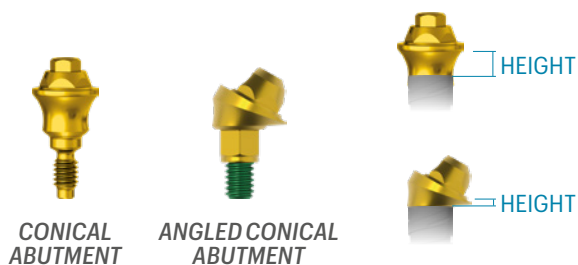

#### How to use the straight conical abutment

- Step 1: Insert the conical abutment on the implant in the correct position using the plastic carrier that is supplied together. If the height of the transporter is too high, it can be cut. Use the screwdriver to tighten the abutment into the implant.
- Step 2: Once the abutment has been rotated with the carrier and put into position, the plastic carrier can be manually detached from the abutment.
- Step 3: Screw in the abutment using the conical abutment driver with a torque of 30 Ncm using the dynamometric key JDtorque or the prosthetic driver connected to the handpiece.
- Step 4: Verify the correct seating of the abutment into the implant by using a radiographic imaging.



**How to use the angled conical abutment**

- Step 1: Insert the conical abutment on the implant in the correct position using the pre-mounted transporter that is supplied together. The pre-mounted transporter is used to facilitate proper positioning of the abutment, because various configurations for abutment positioning are possible.
- Step 2: Insert the screw supplied with the abutment and tighten with a torque of 30 Ncm by means of the prosthetic screwdriver inserted in the dynamometric key JD Torque or using the prosthetic driver connected to the handpiece.
- Step 4: Once the abutment has been torqued into place, it's possible to remove the transporter from the top of the conical abutment.
- Step 5: Verify the correct seating of the abutment into the implant by using a radiographic imaging

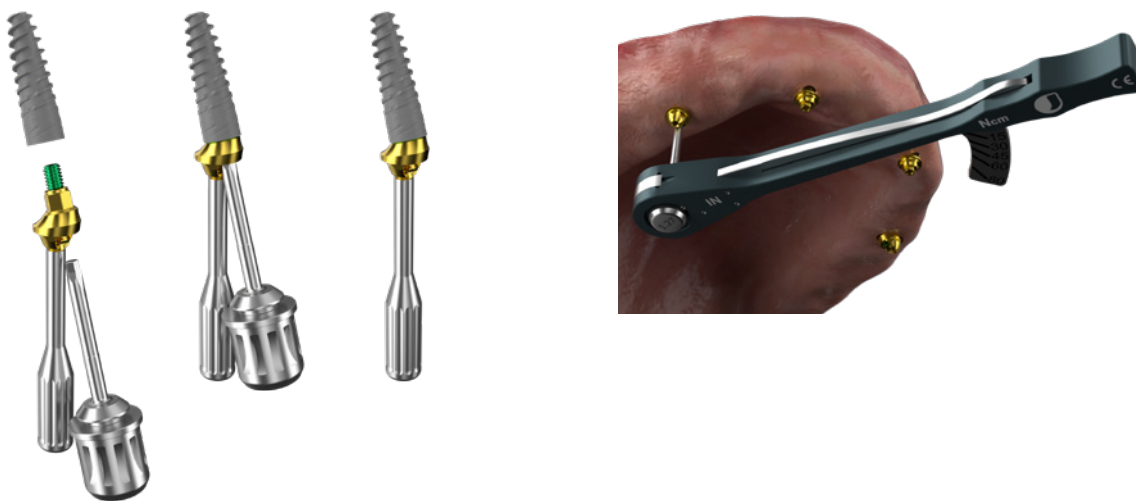

In case of conical abutment, the procedures to take a closed and open tray impressions are described at pp. 36-37.

**Laboratory procedure for conical abutment**

- Step 1: Place the wax-up abutment for conical abutment on its replica, that was previously placed into the model.
- Step 2: Realize the temporary/definitive bridge using conventional methods, making an access hole to allow the insertion of the prosthetic screwdriver.
- Step 3: Fill the bridge with temporary/definitive cement, and place it on the conical abutment.
- Step 4: Remove any excess cement.
- Step 5: Remove the abutment+bridge system from the conical abutment replica, place it on the implant and tighten the prosthetic screw.

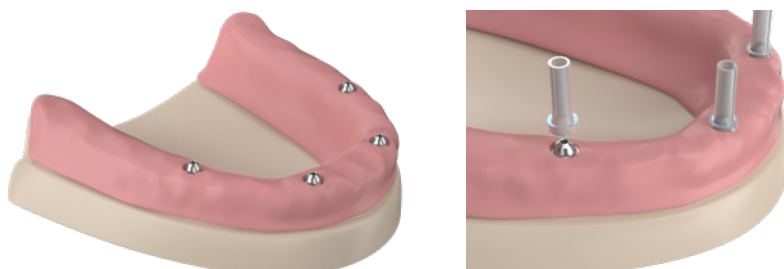



- **Step 6:** Where necessary, cover the access hole in the crown/bridge, with cotton and sealing compound (i.e. gutta-percha, composite). This enables the dentist to remove later the abutment if a modification of the restoration is necessary. The abutment shall be inserted with a torque of 15 Ncm using the prosthetic screwdriver+ JDTorque dynamometric key or with the screw driver connected to the handpiece.

### GP abutment, Temporary Abutment and interface CAD-CAM for Conical Abutments

GP abutment for Conical Abutments, Temporary Abutment for Conical Abutment and Interface CAD-CAM for Conical Abutment are used for screw-retained provisional multiple-unit restorations.

#### How to use GP Abutment/Temporary Abutment for Conical Abutment

- **Step 1:** After positioning the Conical Abutment, place the GP Abutment / Temporary abutment for conical abutment on it and tighten the Prosthetic Screw for Conical Abutment using the prosthetic screwdriver.
- **Step 2:** Check the direction and the length of the GP Abutment / Temporary abutment with respect to the adjacent teeth and/or implants, and check the necessary occlusal space for the covering materials. Modify the GP Abutment / Temporary abutment, if necessary, in function of the current situation in the mouth of the patient (do not reduce the abutments to less than 4 mm in height).
- **Step 3:** Remove the GP Abutment / Temporary abutment unscrewing the prosthetic screws for conical abutment.
- **Step 4:** Place the GP Abutment / Temporary abutment on the conical abutment replica in the master model and tighten the Prosthetic Screws for Conical Abutment using the prosthetic screwdriver.
- **Step 5:** Realize the temporary / definitive bridge using conventional methods.

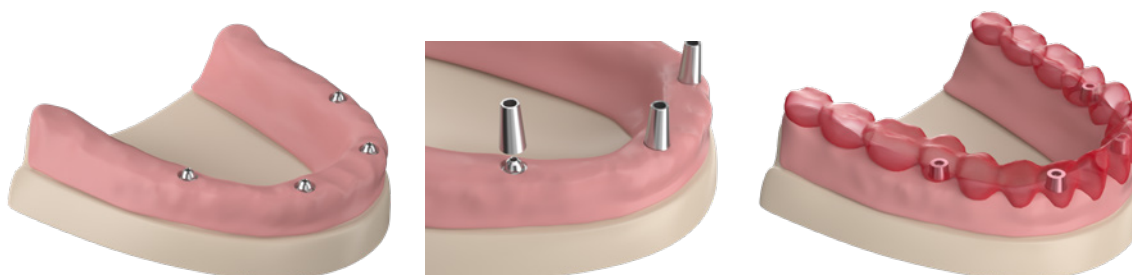

- **Step 6:** The abutment must be cleaned and sterilized, prior to be used in the mouth, following the Cleaning and sterilization instructions for prosthetic components.
- **Step 7:** Place the GP Abutment / Temporary abutment on the conical abutments and tighten the prosthetic screws for conical abutment using the prosthetic screwdriver. Cover the screw access channel of the abutments with cotton and sealing compound (i.e. gutta-percha). This enables the dentist to remove later the abutment if a modification of the restoration is necessary.

- Step 8: Try the temporary/definitive bridge in the patient's mouth and, if necessary, modify it, taking care to protect the abutment connection while making changes.
- Step 9: Fill the restoration with temporary/definitive cement, and place it on the GP Abutment / temporary abutment for conical abutment.

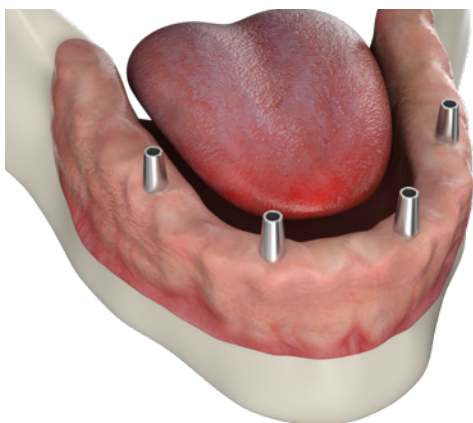

- Step 10: Remove any excess cement.

**Note:** The GP Abutment / Temporary abutment for conical abutment shall be inserted with a torque of 15 Ncm using the prosthetic screwdriver+JD Torque dynamometric key or the prosthetic driver connected to the handpiece.

**How to use Interface CAD-CAM for Conical Abutment**

- Step 1: After positioning the Conical Abutment, place the ScanBodys for conical abutment and take the digital impression.
- Step 2: Design the final prosthesis by using the CAD-CAM Interface for Conical Abutment included in the digital software compatible with the JDentalCare Libraries (Exocad, 3Shape, DentalWings, ecc...).
- Step 3: Once the final prosthesis has been realized using the CAD-CAM protocol, proceed with the matching between the Interface CAD-CAM and the prosthesis.
- Step 4: After the matching has been completed, cement the framework on the Interface CAD-CAM for Conical Abutment and remove any excess cement.
- Step 5: Disinfect and sterilize the prosthesis before the insertion in patient's mouth.

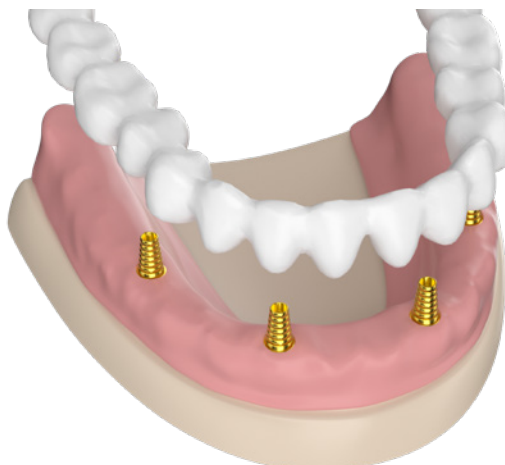



## DEFINITIVE SOLUTIONS FOR CEMENT-RETAINED RESTORATIONS

### Octa Abutment

The Octa abutments are intended only for screw-retained definitive multi-units restorations.



**OCTA  
ABUTMENT**

- Step 1: Insert the octa abutment on the implant in the correct position
- Step 2: Screw in the abutment with a torque ranging from 15 to 35 Ncm using the dynamometric key JDTorque or the screw driver connected to the handpiece.
- Step 3: Verify the correct seating of the abutment into the implant by using a radiographic imaging.  
In case of octa abutment, the procedures to take a closed and open tray impressions are described at page 37.

### Laboratory procedure for octa abutment

- Step 1: Place the wax-up abutment for octa abutment on its replica, that was previously screwed into the impression.
- Step 2: Realize the temporary/ definitive bridge using conventional methods, making an access hole to allow the insertion of the prosthetic screwdriver.
- Step 3: Fill the bridge with temporary/definitive cement, and place it on the octa abutment.
- Step 4: Remove any excess cement.
- Step 5: Remove the abutment+ bridge system from the octa abutment replica, place it on the implant and tighten the prosthetic screw.
- Step 6: Where necessary, cover the access hole in the crown/bridge, with cotton and sealing compound (i.e. gutta-percha, composite). This enables the dentist to remove later the abutment if a modification of the restoration is necessary. The abutment shall be inserted with a torque ranging from 15 to 30 Ncm using the prosthetic screwdriver+ JDTorque dynamometric key or with the screw driver connected to the handpiece.

### Temporary Abutment and Interface CAD CAM for Octa Abutments

Temporary Abutment for Octa Abutment for Octa Abutment are used for screw-retained provisional or definitive multiple-unit restorations.

#### How to use

- Step 1: After positioning the Octa Abutment (see pg. 45), place the Temporary Abutment/Interface CAD CAM for octa abutment on it and tighten the Prosthetic Screw for Octa Abutment using the prosthetic screwdriver.
- Step 2: Check the direction and the length of the Temporary Abutment with respect to the adjacent teeth and/or implants, and check the necessary occlusal space for the covering materials.
- Step 3: Remove the Temporary Abutment unscrewing the prosthetic screws for octa abutment.
- Step 4: Place the Temporary Abutment on the octa abutment replica in the master model and tighten the Prosthetic Screws for Octa Abutment using the prosthetic screwdriver.

- **Step 5:** Modify the Temporary Abutment if necessary, in function of the current situation in the mouth of the patient, verifying the necessary occlusal space for the covering materials (do not reduce the abutments to less than 4 mm in height).
- **Step 6:** Realize the temporary/ definitive bridge using conventional methods.
- **Step 7:** After modifying the abutment, it must be cleaned and sterilized, prior to be used in the mouth, following the Cleaning and sterilization instructions for prosthetic components at pg. 56.
- **Step 7:** Place the Temporary Abutment on the octa abutments and tighten the prosthetic screws for octa abutment using the prosthetic screwdriver. Cover the screw access channel of the abutments with cotton and sealing compound (i.e, gutta-percha). This enables the dentist to remove later the abutment if a modification of the restoration is necessary.
- **Step 8:** Try the temporary/definitive bridge in the patient's mouth and, if necessary, modify it, taking care to protect the abutment connection while making changes.
- **Step 9:** Fill the restoration with temporary/definitive cement, and place it on the Temporary Abutment/Interface CAD CAM for octa abutment.
- **Step 10:** Remove any excess cement.

**Note:** The Temporary abutment/Interface CAD CAM for octa abutment shall be inserted with a torque of 30Ncm using the prosthetic screwdriver+JDTorque dynamometric key or the screw driver connected to the handpiece.

## CAD-CAM PROSTHETIC CUSTOMIZED SOLUTION: TI-BASE ABUTMENT

The Titanium base (Ti-base) has been introduced to allow the clinicians to have a CAD-CAM prosthetic customized solution. After all the passages described in the protocol of intraoral scanning, it's possible to use the geometry of JDentalCare Ti-base abutments that is saved in JDentalCare libraries, to make an easy and simple design and manufacturing of the restoration that is than cemented or bonded to the titanium base extraorally and then inserted into the dental implant. The shoulder of the Ti-base is available with heights of 0.5, 1.5 and 3.0 mm to provide solutions for cases of different gingival thickness.

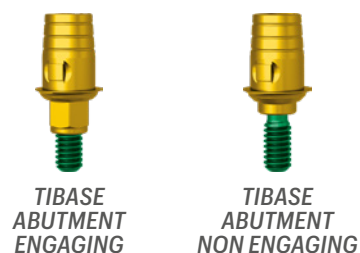

### How to use

- **Step 1:** After the surgery, place the ScanBody and take the digital impression.
- **Step 2:** Design the final prosthesis by using the Ti-Base Abutment included in the digital software compatible with the JDentalCare Libraries (Exocad, 3Shape, DentalWings, ecc...).
- **Step 3:** Once the final prosthesis has been realized using the CAD-CAM protocol, proceed with the matching between the Ti-Base Abutment and the prosthesis.
- **Step 4:** After the matching has been completed, cement the framework on the Ti-Base Abutment and remove any excess cement.
- **Step 5:** Disinfect and sterilize the prosthesis before the insertion in patient's mouth.

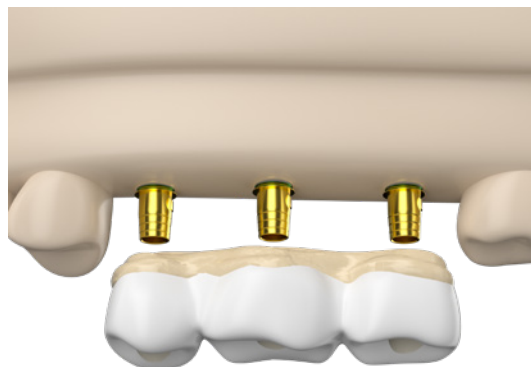

## EXTENSION ABUTMENT (ONLY FOR JDNow DENTAL IMPLANTS)

After the placement of JDNow dental implant it's possible, if considered necessary, to increase the retention of the abutment, screwing the Extension Abutment to the implant.

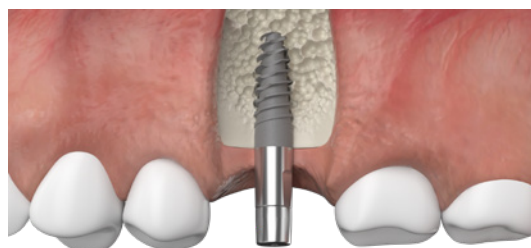

## DEFINITIVE SOLUTIONS FOR CONOMETRIC PROSTHESES

Conometric Abutments Conometric abutments are used for conometric prostheses with single-unit or multiple-unit restorations.



**STRAIGHT AND ANGLED  
CONOMETRIC ABUTMENT**

### **How to use**

- Step 1: Make a master model with one or more Conometric Abutment Replica inserted inside.
- Step 2: Place the Conometric Cap on the conometric abutment replica and activate the conometry exerting a vertical force on the head of the caps.
- Step 3: Perform a wax-up of the crown or of the multiple-unit restoration by bringing into contact a laboratory spacer on the occlusal flat space of the cast.
- Step 4: Realize the crown or the multi-unit restoration by casting or CAD CAM technologies. Leave the Conometric cap on the conometric abutment replica.
- Step 5: Finish the base of the crown and carry out ceramisation. The crown must not be fixed on the Conometric cap yet.
- Step 6: Insert the conometric cap on the conometric abutment inserted in the implant, and activate the conometry exerting a manual pressure.
- Step 7: Fix the crown to the cap.

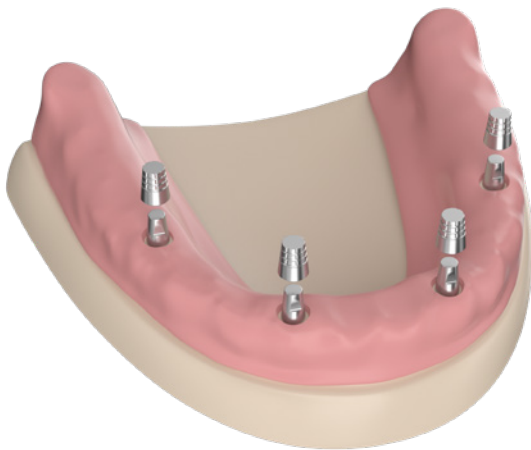

## DEFINITIVE SOLUTIONS FOR OVERDENTURE: BALL ABUTMENT AND EMI ABUTMENT

Ball Abutments and Emi abutments are used as anchoring system for overdentures.

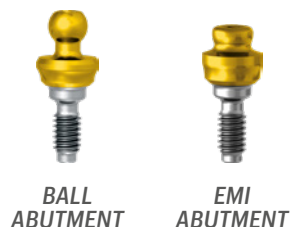

### How to use

- Step 1: Choose the ball abutment or the emi abutment with the appropriate height and connect it to the head of the implant using the prosthetic screwdriver.
- Step 2: After placement of the abutment, it is advisable to take a radiograph to check the position.
- Step 3: Take the impression with the conventional technique. When the material has hardened, it's possible to take out the impression and connect the ball abutment or the emi abutment replicas in the empty spaces left by the ball abutment or the emi abutment. Since the head is always the same for all implant platforms, there is only one replica for the emi and the ball abutment respectively.
- Step 4: Make a master model with the ball abutment or the emi abutment replicas inserted inside.
- Step 5: Block the abutment replicas and prepare an occlusal rim. Send to the dentist for interocclusal records.
- Step 6: Prepare the overdenture using the conventional technique.
- Step 7: Place the cap attachment, assembled with the elastic retentive cap, on the head of ball abutment or the emi abutment so that they are parallel to each other with respect to the horizontal and vertical planes.
- Step 8: Make the overdenture using the conventional technique, checking that the overall dimensions of the (ball or the emi) abutment and the cap attachment are completely included in the prosthesis.
- Step 9: Put the overdenture into place to test the retentive capacity of the caps and eventually to adjust the retentiveness.



## JD TORQUE

The dynamometric JD Torque key has been designed and developed for surgical and prosthetic use. The instrument can be used as a dynamometric or fixed key. Design, functionality, practicality, and light weight are the strengths of this instrument. The great mechanical resistance together with the high elasticity of the PEEK™ polymer allows the JD Torque dynamometric key to take measurements up to 80Ncm. On the other hand, this material is extremely light compared to metals and can be subjected to sterilization in autoclaves with temperatures up to 134°C without altering its mechanical characteristics.



## JDENTALCARE KITS

JDentalCare manufactures and supplies a series of Surgical Kits, with the aim to provide all the necessary for dental implant placement. They contain a set of drills, drivers and screwdrivers combined so that they can be adapted to each JDentalCare implant line. JDentalCare kit boxes are intended for use in healthcare facilities to organize, enclose and store medical device between surgical uses. The kit box of JDSurgical Kit is also suitable for frequent sterilization in the autoclave. For information about compatible instruments for each implant line please refer to the IFUs of each implant line and of surgical instruments available at [ifu.jdentalcare.com](http://ifu.jdentalcare.com).



## CLEANING AND STERILIZATION INFORMATION

Devices sold in NON-STERILE form are marked with the following symbol on the label:



Devices sold in STERILE form are marked with the following symbol on the label:



The sterility information is summarized in the following table:

Devices	Sterile / Non sterile	To be sterilized prior to use	Single use/ Reusable
Implant fixture	Sterile	No	Single use
Prosthetic components	Non sterile**	Yes	Single use
	Sterile**	No	Single Use
Surgical Instruments	Non sterile	Yes	Reusable

*\*\* Please pay attention to the symbology on the label to distinguish whether the product is supplied in sterile form or not.*

### Sterility information for Implants and Prosthetic Components

JDentalCare implants are delivered sterile. Implants have been sterilized using gamma irradiation and are single-use devices. The intact sterile packaging protects the sterilized implant from outside influences and, if stored correctly, ensures the sterility of the device up to the expiration date.

The expiration date is indicated on the labels attached on the blister and on the box. The sterile blister must be opened only at the point of use during the surgery. On the blister of implants there is a red sticker, which is a gamma sterilization indicator. It confirms that the device has been subjected to sterilization by gamma radiation.

Prosthetic components may be supplied non-sterile or sterile and are single-use devices. Please pay attention to the symbology on the label to distinguish whether the product is supplied in sterile form or not, and more specifically check which of the two symbols shown above is on the label.

In case of sterile prosthetic components, they have been sterilized using gamma irradiation. The intact sterile packaging protects the sterilized prosthetic component from outside influences and, if stored correctly, ensures the sterility of the device up to the expiration date.

The expiration date is indicated on the label attached on the cardboard case. The sterile packaging must be opened only at the point of use during the surgery. On the envelope in which the device was placed, there is a red sticker, which is a gamma sterilization indicator. It confirms that the device has been subjected to sterilization by gamma radiation.

In case of non-sterile prosthetic component, it must be sterilized by the user prior to use, through steam sterilization, as follows\*:

- For US Market: Temperature: 132° C / 270° F; Sterilization Time: 4 min; Dry Time: 20 min; Pressure: 3 bar; Density of worst-case load: 0,09 gr/ cm<sup>3</sup>
- For EU market: Temperature: 134° C / 273° F; Sterilization Time: 4 min; Dry Time: 20 min; Pressure: 3 bar; Density of worst-case load: 0,14 gr/ cm<sup>3</sup>

Prosthetic components should be sterilized in sterilization pouches that must be in medical grade paper and plastic film suitable for steam sterilization and must comply with the requirements of the EN ISO 11607: 1-2 and UNI EN 868-5 standards

**Note:** For a correct efficiency of sterilization process, it is recommended to use B-Autoclave, and to regularly perform control tests suggested in the manufacturer Manual. We recommend to keep and archive all records in a spe-

cific document easy to consult in the workplace.

\*Validated sterilization parameters to achieve a Sterility Assurance Level (SAL) of 10<sup>-6</sup> in accordance to EN ISO 17665-1.

Please refer to product labels for information related to devices sterilization and reusability

**Warning:** The devices are SINGLE USE. Do not re-use the devices (both implants and prosthetic components). Used or explanted devices cannot be reused/resterilized and must be disposed. If they are reused on another patient, there is a risk of cross-contamination and loss of the performance and functional characteristics of the device.

**Warning:** Do not use sterile devices after the expiration date.

**Warning:** Do not use fixtures and the prosthetic components when supplied sterile if the gamma sterilization indicator is colored differently from red. Previously used or non-sterile implants must not be used under any circumstances.

**Warning:** The fixtures must not be cleaned, disinfected and/or re-sterilized by the users prior to use, since otherwise the main material and design features may be compromised, leading to device failure.

**Warning:** The device (both implants and prosthetic components) can be used only if the package is intact, closed and undamaged. Don't use the devices (both implants and prosthetic components) if the package has been damaged or previously opened. It is recommended to have a replacement implant at hand.

Any behavior different from the above may lead to infections, implant loss and to the failure of the treatment. JDentalCare disclaims any liability and shall have no responsibility for re-sterilized implants, regardless of who has carried out re-sterilization or by what method.

**Sterility information for Surgical instruments and Kits**

Surgical instruments are intended for reuse. Prior to first use and each use thereafter the devices must be cleaned and disinfected by the user according to the instruction reported below(with manual or automatic process), then must be sealed, individually or within surgical kit, in a sterilization pouch and sterilized.

**Warning:** Use of non-sterile device may lead to infection of tissues or infectious diseases.

**Warning:** The device can be used only if the package is intact, closed and undamaged. Do not use the devices if the packaging has been damaged or previously opened.

**Warning:** In the event of suspected prion contamination, do not reuse the device, but safely dispose of it in accordance with applicable laws and regulations.

**Warning:** JDentalCare has validated the sterilization process to ensure sterile instruments for 6 months inside the SBS. Do not use sterile devices after this period.

**Warning:** Failure to follow manufacturer directions may expose the patient to infection

**Cleaning and sterilization instruction**

The following cleaning and sterilization process have been validated according to international standards and guidelines, the main are reported as follow:

Cleaning and disinfection	Steam Sterilization
- ISO 17644 - ASTM E 2314-03 - ISO 11737 - ISO 15883-5 - ANSI/AAMI ST98:2022	ISO 17665-1 ISO/TS 17665-2 UNI EN ISO 11138-1

According to EN ISO 17664, it is the responsibility of the user/processor to ensure that the processing/reprocessing is performed using equipment, materials and personnel which are suitable to ensure the effectiveness of the processes. Any deviation from the following instructions should be validated by the user/processor to ensure the effectiveness of the process.

**Note:** the manufacturer's instruction for use for any detergent/cleaning solution must be strictly followed where ap-



*plicable, it is recommended to use the same/ simile products and materials as indicated by JDentalCare.*

**Note:** *the recommended water used for diluting cleaning agents and/ or disinfectants are purified water-PW/ or highly purified water-HPW with less than 0,25 U.I/ ml of bacterial endotoxins and maximum 10 CFU/ml for HPW and WFI.*

### **Initial treatment and pre-cleaning instruction for surgical instruments and kits:**

#### **Initial treatment at the point of use**

The device is supplied in a NON-STERILE state and before first use it must undergo the cleaning, disinfection and sterilization procedures indicated in this instruction sheet. Before use, always examine the device in order to verify its integrity, the absence of stains, damage or wear. Start cleaning the reusable parts as soon as possible after use to ensure the efficacy of the reprocessing.

#### **Pre-Cleaning**

##### **Surgical instruments**

To avoid contamination of the kit box (mainly the instrument tray) and damage of sterile gloves by sharp drills it is recommended to pick up devices using a pair of tweezers. Directly after use of reusable tools remove gross soiling using a specific absorbent paper wipe. If needed rinse with running water.

- Get the medical devices to the point where cleaning is to be performed as soon as practical using specific containment for safe transportation
- Soak the instruments in 2% of disinfecting solution (Ex. ID 212- DURR DENTAL) for minimum 5 min to guarantee a safe handling by the personnel in the next steps of the process. Soaking time not less than specified in the disinfecting agent manufacturer's instructions\*
- Surgical tools must be disassembled into several parts before brushing: when using twist drills with stops remove them before brushing step. When using drill extension remove it before brushing step
- After disassembly, use a soft nylon-bristled brush to gentle scrub the devices, particular attention must be given to critical area as crevices, serrations, joints and lumen. Lumen should be clean with an appropriate pipe cleaner. Brush the devices for a minimum of 30 second until all visible soils is removed.
- After brushing, rinse with running water for a minimum 1 minute to remove any residue of soil and traces of disinfecting agent

In case of highly contaminated medical devices to be subjected to an automatic cleaning process, perform a final pre-cleaning step in an ultrasonic bath: Immerse the devices in an ultrasonic bath containing 2% of disinfecting solution (Ex. ID 212- DURR DENTAL) for 5 min at room temperature (25° C / 77° F)

**Note:** *Maximum soaking time for IDI 212 agents is 12 hours. For different cleaning/disinfectant agents please consult manufacturer's instruction for use.*

The solution used for cleaning and rinsing must be replaced after each use.

*\*Pre-Cleaning and Cleaning phase has been validated by JDentalCare using commercial product ID 212 by DURR DENTAL.*

##### **Kit boxes**

In case of suspect contamination of the autoclavable container with biological material, it is advisable to proceed with the disassembly of the silicone rubber and support from the tray. Remove the larger impurity from the plastic parts under a jet of water at room temperature using also a brush. If the silicon supports have been removed, dry the container before reassembly. A visual inspection can verify the integral state of the container.

**Note:** *The solution used for cleaning and rinsing must be replaced after each use.*

*\*Pre-Cleaning and Cleaning phase has been validated by JDentalCare using commercial product HI CARE 2.0 PERA-CETIX DROX of Negri sas*

## **Manual Cleaning**

### **Surgical instruments**

Start cleaning the reusable surgical instruments immediately after pre-cleaning.

- Immerse the devices in an ultrasonic bath containing 2% of cleaning solution (Ex. ID 212- DURR DENTAL) for minimum 5 min at room temperature (25°C/77°F)
- After cleaning steps rinse in purified running water for a minimum 1 minute to remove any residue of soil and traces of cleaning solution.

Refer to the detergent manufacturer's instruction for use for additional rinsing instruction

**Note:** *Maximum soaking time for IDI 212 agents is 12 hours. For different cleaning/disinfectant agents please consult manufacturer's instruction for use.*

The solution used for cleaning and rinsing must be replaced after each use.

*\*Pre-Cleaning and Cleaning phase has been validated by JDentalCare using commercial product ID 212 BY DURR DENTAL.*

### **Kit boxes**

Start cleaning the kit boxes immediately after pre-cleaning.

- Immerse the container in a detergent solution in an ultrasonic bath for 10 min
- Rinse the container with tap water at room temperature for 1 minute to eliminate residual traces of detergent
- Place maximum attention to the dosages of the products used and to the treatment times indicated by the manufacturer

**Note:** *The solution used for cleaning and rinsing must be replaced after each use.*

*\*Pre-Cleaning and Cleaning phase has been validated by JDentalCare using commercial product HI CARE 2.0 PERACETIX DROX of Negri sas.*

## **Manual Disinfection**

### **Surgical instruments**

- Immerse the devices in an ultrasonic bath containing 0.55% of disinfecting solution (Ex. CIDEX OPA By ASP) for a minimum of 5 minutes at minimum 20° C / 65° F.
- After disinfection steps rinse in purified running water for a minimum 1 minute to remove traces of disinfecting agent

**Note:** *The solution used for cleaning and rinsing must be replaced after each use.*

*\*Disinfection phase has been validated by JDentalCare using commercial product CIDEX OPA By ASP*

### **Kit boxes**

- Immerse the container in a disinfectant solution in an ultrasonic bath for 10 min
- Rinse the container with tap water at room temperature for 1 minute to eliminate residual traces of disinfectant
- Place maximum attention to the dosages of the products used and to the treatment times indicated by the manufacturer

**Note:** *The solution used for disinfection and rinsing must be replaced after each use.*

*\*Pre-Cleaning and Cleaning phase has been validated by JDentalCare using commercial product HI CARE 2.0 PERACETIX DROX of Negri sas*

**Caution:** *For a correct efficiency of surgical instruments, we advise 20-30 uses maximum.*

## **Automatic Cleaning**

The following washer was used in the JDentalCare validation: Smeg Instruments WD2145 with the following P7 custom program.

- 1 - Place the device in a suitable instruments rack (E.g metal sieve basket) and load them into the washer/disinfector. Ensure the rack or load carrier is oriented in a horizontal position.
- 2 - Performed automatic cleaning. The following parameters are based on the P7 TD program 90° x 5 minutes

(AO= 3.000) on the SMEG WD2145 washer disinfectant:

- 3 minutes of prewashing with cold filtered water
- Washing with mildly alkaline detergent, dosage 4 ml/l (0.4%), filtered water
  - Step 1: 5 minutes at 50°C
  - Step 2: 5 minutes at 55°C
- 3 minutes of neutralization with cold water
- 3 minutes of rinsing with deionized water
- 5 minutes of disinfection at 90° with deionized water
- Draining

**Note:** Automatic washing steps have been validated by JDentalCare using commercial product Neodisher MediClean Forte. Neutralization steps have been performed with Acidglass C2.

### 3 - Inspection and maintenance

- Visually inspect all devices for signs of damage and wear. Cutting edges should be free of defects and drills should be free from distortion. Visually inspect kit box for signs of damage and wear.
  - Re-assemble the surgical kit (tray) and place the tools to be sterilized in their proper supports which will hold them still during the sterilization cycle
  - Laboratory tools should be inserted into the silicon support by their stems, leaving the area to be sterilized uncovered. Surgical tools should be inserted handle first and not by their working end. The tray with utensils should be placed inside the container which can then be closed
  - Only devices manufactured should be included in JDentalCare instrument tray. These validated reprocessing instructions are not applicable to trays that include devices that are not manufactured by JDC.
- These validated reprocessing instructions are not applicable to trays that include devices that are not manufactured by JDentalCare.

**Caution:** For a correct efficiency of surgical instruments, we advise 20-30 uses maximum.

## **Drying**

### **Surgical instruments**

Dry the tools with a clean, absorbent and non-shedding wipe until completely dry. Carefully inspect each device to ensure that all visible contamination (soil or debris) has been removed. If necessary, repeat cleaning and disinfections steps.

### **Kit boxes**

Dry the container with clean and soft cloth. Carefully inspect the kit box to ensure that all visible contamination (soil or debris) has been removed. If necessary, repeat manual cleaning and disinfection. After cleaning steps rinse in purified water for a minimum 1 minute to remove any residue of soil and traces of cleaning solution.

## **Inspection and maintenance**

Visually inspect all devices for signs of damage and wear. Cutting edges should be free of defects and drills should be free from distortion.

Visually inspect kit box for signs of damage and wear

- Re-assemble the surgical kit (tray) and place the tools to be sterilized in their proper supports which will hold them still during the sterilization cycle
- Laboratory tools should be inserted into the silicon support by their stems, leaving the area to be sterilized uncovered. Surgical tools should be inserted handle first and not by their working end. The tray with utensils should be placed inside the container which can then be closed
- Only devices manufactured should be included in JDentalCare instrument tray. These validated reprocessing instructions are not applicable to trays that include devices that are not manufactured by JDentalCare.

### **Packaging**

- Surgical instruments should be sterilized individually in sterilization pouches or within surgical kit in sterilization pouches. The pouches must be in medical grade paper and plastic film suitable for steam sterilization and must comply with the requirements of the EN ISO 11607: 1-2 and UNI EN 868-5 standards
  - The packaging should be reported variable data as number of sterilization cycle, packaging and expiry date
- JDentalCare has validated the sterilization process to ensure sterile instruments for 6 months inside the SBS.

### **Sterilization**

For steam sterilization of the JDentalCare reusable instruments and surgical kit sterilize as follow\*:

- For US Market: Temperature: 132° C / 270° F; Sterilization Time: 4 min; Dry Time: 20 min; Pressure: 3 bar; Density of worst-case load: 0,09 gr/ cm<sup>3</sup>
- For EU market: Temperature: 134° C / 273° F; Sterilization Time: 4 min; Dry Time: 20 min; Pressure: 3 bar; Density of worst-case load: 0,14 gr/cm<sup>3</sup>

**Caution:** do not re-sterilize the same instrument for more than 30 times.

**Note:** For a correct efficiency of sterilization process, it is recommended to use B-Autoclave, and to regularly perform control tests suggested in the manufacturer Manual. We recommend to keep and archive all records in a specific document easy to consult in the workplace.

\*Validated sterilization parameters to achieve a Sterility Assurance Level (SAL) of 10<sup>-6</sup> in accordance to EN ISO 17665-1.

### **Storage and Transportation**

After sterilization, sterile kit with devices should be stored in a limited access area away from dust, moisture, vermin and temperature humidity extremes. Packaging should be carefully examined prior to opening to ensure the integrity.

Maximum storage time: 6 months

**Warning:** do not use device if the packaging has been damaged or previously opened.

**Note:** It is recommended to implemented a traceability system including all sterilization phases in order to identify the operator responsible of the process. The following information shall be reported on the pouches:

- Initials of the operator responsible for the sterilization cycle
- Number of sterilization cycle
- Packaging and expiry date

### **Disposal**

Disposal of the device shall follow local regulations and environmental requirements taking different contamination levels into account.

## IMPLANT AND SCREW REMOVAL TOOLS

### Implant removal tool

The implant removal tool EVIRT can be used to remove implants when the implant's connection is damaged and the ordinary implant driver cannot be used to extract it. The EVIRT implant removal tool shall be used by performing counter-clockwise rotations. The EVIRT implant removal tool has an external hexagon that fits with the JDTWAP Prosthetic Adapter for JD Torque and the EVSUD and EVSUDMAX surgical drivers.

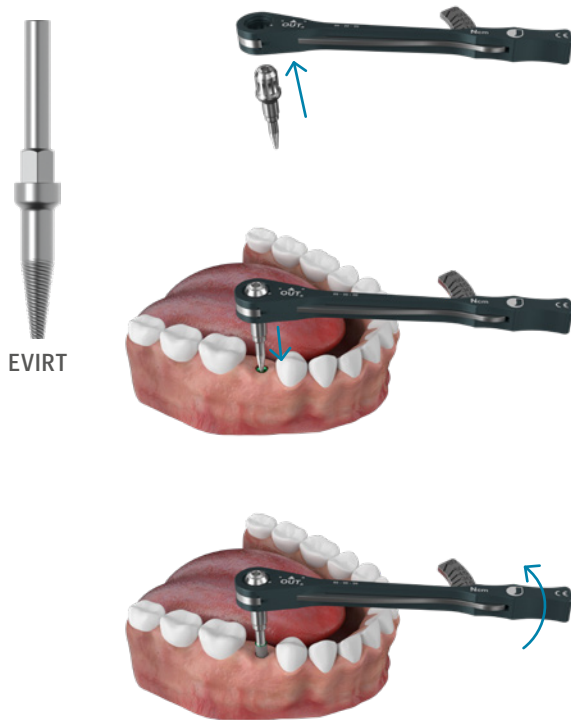

### Screw removal tools

The screw removal tools can be used to remove a broken screw from an implant with an internal hexagonal connection. Such tools can be used when the prosthetic screw connecting the abutment to the fixture is damaged and cannot be removed with the prosthetic screwdriver. It is possible to remove a broken screw from an implant if it has not been fixed with cement or if it has not been damaged during a previous removal attempt. Insert the EVCD Centering device JDEvolution into the implant and try to engage the broken screw with the EVEX1 claw drill mounted on the JDTWAPM manual prosthetic adapter, exerting constant pressure and rotating counterclockwise. In case the broken screw is locked, place the EVEX1 Claw Drill into the handpiece. Set the handpiece rotation counterclockwise without ever exceeding the maximum speed of 600 rpm and insist on the broken screw to flatten it. Remove the EVEX1 Claw drill from the handpiece and insert the EVEX2 Reverse cutting drill in its place. Set the rotation of the program counterclockwise without ever exceeding the maximum speed of 600 rpm. During this operation proceed with plenty of water irrigation. Place the EVEX2 Reverse cutting drill in the EVCD centering device, start the spindle rotation, hold it for no more than 3 seconds on the broken screw and release it. This will result in the progressive destruction of the broken vine. It is absolutely necessary that the EVCD centering device remains stationary in its

position during the entire operation, as if the EVCD moves, the EVEX2 may be subject to breakage. Once the screw is destroyed, any fragment or residue can be removed from the cavity with air, water and/or suction.

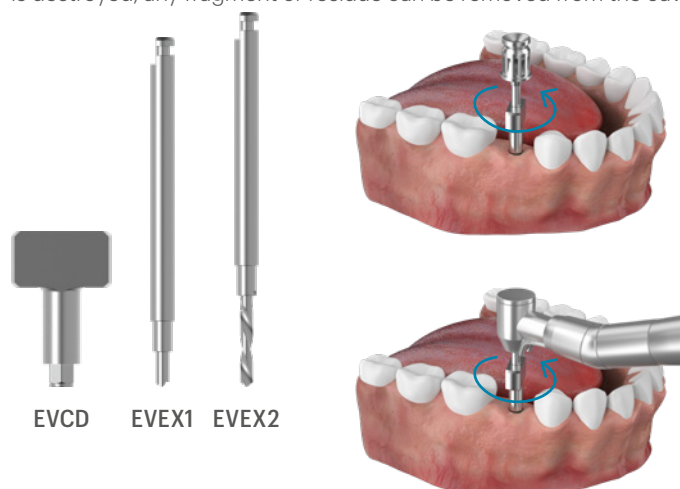

### **JD internal thread repair tool**

The EVTR Internal Thread Repair tool can be used to repair the internal thread of the system in case it is damaged. It can be used with JDEvolution implants. The instrument must be mounted in the JDTWAPM manual prosthetic adapter and, after being inserted into the implant to be repaired, it is necessary to proceed with gentle movements rotating clockwise. This instrument is to be used only manually, therefore without recourse to handpiece or contra-angle.





**JDENTAL CARE**

*just smile*

JDentalCare, the JDentalCare logo and other trademarks mentioned in this document are, excluding specifically mentioned exceptions, trademarks property of JDentalCare. The images of the products represented in this brochure are not necessarily to scale.

Notice: Some products of this catalogue, manufactured by JDentalCare may not have been regulatory cleared/released for sale in all countries. For more information about current product assortment and availability, please contact your local JDentalCare distributor. For prescription use only.

Caution: Federal (US) law restricts this device to sale by or on the order of a licensed dentist.

See Instructions for Use for more information such as indications, warnings, precautions and contraindications.

SGMNL\_Rev.02 of 2025-02-07